

## Simulation Study Of 802.11b DCF Using OPNET Simulator

Dr. Mohammad Hussian Ali\* & Manal Kadhim Odah\*\*

Received on: 1/6/2008

Accepted on: 26/1/2009

### Abstract

A simulation study of an IEEE 802.11b which is the most important standard for wireless local area networks was presented in this paper. The simulation is conducted using OPNET IT Guru Academic Edition 9.1. Wireless network performance depends mainly on the end to end throughput and average delay. Different applications place different requirements on the network. Thus, it is necessary to evaluate and analysis the performance of IEEE 802.11b WLAN system under the fundamental access mechanism for medium access control (MAC) called distributed coordination function (DCF). This can achieve by studying the impact of parameters such as Request to Send/ Clear to Send (RTS/CTS), Fragmentation Threshold (FTS) and discuss the best configurations and parameters value in correspondence to network load and topology to get best performance which is the main objective of this paper.

### دراسة لمحاكاة الشبكة اللاسلكية 802.11b باستخدام محاكي الأوبنيت

#### الخلاصة

هذا البحث يقدم دراسة لمحاكاة الشبكة اللاسلكية (802.11b) التي تعتبر من أهم مقاييس الشبكات المحلية اللاسلكية. المحاكاة تمت باستخدام محاكي الأوبنيت. إن أداء الشبكة اللاسلكية يعتمد بصورة رئيسية على كمية المعلومات التي يتم معالجتها (throughput) ومعدل التأخير (average delay). التطبيقات المختلفة تستدعي متطلبات مختلفة للشبكة. لذلك من الضروري إيجاد وتحليل الأداء للتقنية الأساسية للاتصال بالوسط للمقياس (MAC). بدراسة تأثير متغيرات مثل إرسال طلب / إرسال إجابة RTS/CTS وعتبة التقطيع (FTS) ومناقشة أفضل تشكيلة وقيم للمتغيرات بالتوافق مع حمل الشبكة وهيئتها للحصول على أداء أفضل وهو الهدف الرئيسي من هذا البحث.

**Keywords:** Wireless LAN, IEEE 802.11, Distributed Coordination Function DCF, Opnet Simulator.

### 1. Introduction

Wireless local area networks (WLANs) based on the IEEE 802.11 standard are one of the fastest growing wireless access technologies in the world today. They provide an effective means of achieving wireless data connectivity in homes, public places and offices. Like IEEE 802.3 (Ethernet) and IEEE 802.5 (Token Ring), the 802.11 standard focuses on the two lower layers (1 and 2) of the Open System Interconnection (OSI) reference model. This is indicated in the reference model of 802.11 illustrated in Figure 1. This reference model divides the Data Link Control (DLC) layer (i.e., OSI layer 2) into

Logical Link Control (LLC) and Medium Access Control (MAC) sub layers.

802.11 defines Physical layer (PHY) transmission schemes (OSI layer 1), and the MAC protocol, but no LLC functionality. For LLC, the 802.11 system may rely on general protocols that are usable with all 802 standards. This LLC layer is independently specified for all 802 LANs, wireless or wired. [1]

The 802.11 standard defines a number of MAC layer coordination functions to coordinate media access among multiple stations. Media access can either be contention-based, as in the mandatory 802.11 distributed coordination function (DCF) which is a fundamental access mechanism of IEEE 802.11 MAC, when

\* Laser Engineering Department, University of Technology / Baghdad

\*\*Electomechanical Engineering Department, University of Technology / Baghdad

all stations essentially compete for access to the media, or contention free, as in the optional 802.11 point coordination function (PCF), which uses a central coordinator for assigning the transmission right to stations, thus guaranteeing a collision free access to DCF has gained enormous popularity and been widely deployed, the use of PCF has been rather limited. The media access method used by the DCF is a carrier sense multiple access protocol with collision avoidance (CSMA/CA) [2]. Our study has focused on evaluating the performance of the 802.11b DCF, by studying the impact of parameters such as Request to Send/Clear to Send (RTS/CTS), Fragmentation Threshold (FTS), data rate and number of mobile station. In the literature, performance evaluation of 802.11 has been carried out either by means of simulation or by means of analytical models. . In [3], the authors provided a simple, but nevertheless extremely accurate, analytical model to compute the 802.11 DCF throughput, in the assumption of finite number of terminals and ideal channel conditions. In [4] the authors, presented an empirical, i.e., measurement based, characterization of the instantaneous throughput of a station in an 802.11b WLAN as a function of the number of competing stations sharing the access point.. The overall throughput decreases slightly as the number of stations increases. The authors in [5] derived throughput formula for the RTS/CTS access method of IEEE 802.11b MAC protocol. The results of the study indicated that the RTS/CTS mechanism produce limited advantages in the standard IEEE networks with respect to the basic access when no hidden stations. The authors in [6] investigated the performance of IEEE 802.11a and b WLAN standards on the Martian surface. They observed that successful communication is possible within a few hundred meters of the transmit antenna when the transmit power is 1 W. In [7], the authors proposed an improvement of the existing DCF scheme in order to cope

with its unfairness limitations. They advised the introduction of relative priorities among different access stations according to their physical transmission bit rate. To achieve this, they used different contention window sizes for each class of bit rate. Finally, they motivated the use of the proposed scheme since it allows achieving fairness among contending access nodes while improving the total network throughput. The rest of the paper includes brief review to the medium access control (MAC) and physical layers of the 802.11b standard, network architectures, configurations and the result of the performance evaluation experiments.

## 2. 802.11b DCF

The IEEE 802.11b DCF mode is based on a “listen before- talk” procedure, where terminals first determine if the medium is free before attempting to transmit. The DCF mode specifies two types of *Inter Frame Spacing* (IFS), including the Distributed IFS (DIFS) and the Short-IFS (SIFS). SIFS is the shortest defined interval with a value of 10 microseconds while DIFS is defined as 50 microseconds. After a transmission the destination station has to send a positive acknowledge (ACK) packets expressing that the data is well received. The ACK is sent after a SIFS period. A station that has a packet to transmit first senses the medium. If the medium is determined to be free for a duration of a DIFS, the station transmits the packet. Otherwise, the station enters the backoff phase in which it chooses a random backoff timer uniformly from a collection of values known as the *contention window*. The standard specifies the minimum contention window to be 32 time slots and the maximum to be 1024, where a timeslot is defined to be 20 microseconds. After a backoff time has been chosen, the station continues to monitor the medium until it observes an idle period equal to a DIFS, after which, it decrements the backoff timer after every idle timeslot. If the medium becomes busy during the countdown, the station suspends the

decrement operation until the channel becomes idle again for a period of DIFS. When the backoff timer reaches zero, the station transmits the packet. Clearly, when multiple stations contend for the medium at the same time, the station that picks the lowest random backoff timer wins and will send its packet first. After every unsuccessful packet transmission the size of the contention window doubles until it reaches its maximum value. Following a failed transmission the sender may attempt to retransmit the packet up to maximum number of times before it is dropped. Following a successful transmission the contention window range is reset to its minimum value. This two-way handshaking technique is basic mechanism of DCF as shown in Figure 2. DCF can also use a four-way handshaking technique for a packet transmission as shown in Figure 3. In this case, this mechanism does exactly the same while contending for a channel. Then instead of transmitting a data packet, a STA sends a RTS frame to the destination STA. If the receiving STA receives this frame, after a SIFS it responds with a CTS frame. Only now transmitting STA is allowed to send its data packet. These RTS and CTS frames carry information about the length of the packet to be transmitted. This information can be heard by any STA within communication radius of a sender and a receiver and they can update their network allocation vector (NAV). With this technique collisions due to the hidden terminals problem can be avoided since the detection of one of those frames (RTS or CTS) will prevent the other STA to start their own transmission. [3] [8]

### 3. Physical Layer

The distinction between different 802.11 technologies is made in Physical layer (PHY). Each PHY layer can consist of two protocol functions. They are: *Physical Layer Convergence function*: This function is supported by the PLCP, which defines a method of mapping MPDU's into a framing format suitable for sending and receiving user data and management information between two or

more STAs using the Physical Medium Dependent (PMD) system. The PMD system function is to define the characteristics of a wireless medium between two or more STAs, such as transmitting and receiving data method. IEEE 802.11 specifies two different PHY specifications:

- Frequency-Hopping Spread Spectrum (FHSS)
- Direct Sequence Spread Spectrum (DSSS). [9]

### 4. WLAN Performance Parameters

There are several parameters that can influence WLAN performance. They can be divided through different groups. An exhaustively set of parameters that influence the measurement parameters is: [2]

#### • WLAN configuration parameters:

The parameters that are configurable in the STAs and its information are a part of 802.11 technologies.

1. RTS/CTS control frames enable/disable
2. MAC Fragmentation enable/disable
3. PLCP PPDU frames long/short
4. Transmission power and range.
5. Contention Window (CW) size.

#### • Traffic parameters:

The parameters that give us information about the network traffic, which is applied to the network setup.

1. TCP/UDP segments: Different applications can use different transport layer protocols
2. Packet length
3. Data Rate
4. Unidirectional/Bidirectional: Data may be transmitted in one direction or in both directions.

#### • Channel parameters:

1. Channel ID: If there is severe signal interference in one area, it is possible to change to another channel by select channel address to avoid the interference.
2. Distance

All of the above parameters affect in a way or another WLAN performance. In this paper some of these parameters mentioned above will be studied, modeled

in different WLAN topologies, simulated in different values, and the results of its effect will be discussed finally. The rest of the parameters mentioned above will be set to constant or standard values.

#### 4.1 Hidden Stations and RTS/CTS

To reduce throughput reduction owing to hidden stations, 802.11 specifies as an option the exchange of Request-to-Send/Clear-to-Send (RTS/CTS) frames. Before transmitting a data frame, a station may transmit a short RTS frame, which must be followed by a CTS frame transmitted by the receiving station. The RTS/CTS mechanism is very effective in terms of system performance, especially when large packets are considered, as it reduces the length of the frames involved in the contention process. [1]

#### 4.2 Fragmentation

To reduce the duration the channel is occupied when frames collide; the protocol provides a fragmentation mechanism, which allows the MAC to split an MSDU (the packet delivered to the MAC by the higher layers) into more MPDUs (packets delivered by the MAC to the PHY layer) as shown in Figure 4. If their length exceeds a certain threshold. The process of partitioning an MSDU into smaller MPDUs is called fragmentation. An MPDU protects the subsequent transmission of its ACK within its duration field, and in addition, when fragmentation is used, transmission of the following MPDU. Fragmentation creates MPDUs smaller than the original MSDU length to limit the probability of long MPDUs colliding and being transmitted more than once. With fragmentation, a large MSDU can be divided into several smaller data frames, i.e., fragments, which can then be transmitted sequentially as individually acknowledged frames. The benefit of fragmentation is that in the case of failed transmission, the error is detected earlier

and there is less data to retransmit. It also increases the probability of successful transmission of the MSDU in scenarios where the radio channel characteristics

cause higher error probabilities for longer frames than can be expected for shorter frames. The process of recombining MPDUs into a single MSDU is called defragmentation, which is accomplished at each receiving station. [1]

### 5. Simulation Environment

In this work, we use OPNET IT Guru 9.1 for our network simulations. OPNET is a powerful communication system simulator developed by OPNET Technologies [10]. OPNET assists with the testing and design of communications protocols and networks, by simulating network performance for wired and/or wireless environments. The OPNET tool provides a hierarchical graphical user interface for the definition of network models as shown in Figure 5.

#### 5.1 FTS and RTS threshold

The fragmentation and RTS threshold were set to be in specific values in addition to the default (none) value. As follows:

Fragmentation threshold parameter was configured in one of two values (16 byte, 256byte).

Also RTS threshold parameter was configured in one of two values (16 byte, 256byte).

#### 5.2 DCF Simulation Project

Figure 6 shows the arrangement of objects in this project. This project contains two main objects: the Access Point and the nodes. The objects were located on (30mx30 m) area.

The AP is a WLAN Server configured to function as AP. While the nodes are WLAN mobile workstation and their AP functionality is disabled. The application profiles boxes shown in the figure are just for application configuration.

Following are the settings, and parameters of this project:

- a) Number of Nodes: The number of nodes in this project was not fixed. The project was simulated with 2 and 10 nodes.
- b) Simulation time: Simulation time was set to one hour.

c) Load: two load conditions were experimented. Low load (Engineer profile), and Heavy load (Multimedia User profile).

d) Physical Characteristics: DSSS was set as fixed attribute for all the projects. Here the standard parameters are introduced as shown in table 1.

e) The configured parameters: those to be changed from scenario to another, in order to examine their effect on network performance under low load, and heavy load conditions.

### 5.2.1 Simulated Scenarios

To demonstrate the effects of Fragmentation Threshold, we employed eleven scenarios with various combinations of number of nodes and data rate. Table 2 shows the simulated scenarios with the combinations of configured parameters, first under low load condition and second repeated under heavy load condition.

The RTS threshold parameters used for the next set of simulation are listed in table 3

## 6. Simulation Results

This section presents selected results from our OPNET simulations. To validate the expected performance improvement, we compute expected throughput and delay for our designed project.

For the first six simulation scenarios, the simulation results (Figure 7 and 8) indicate that for low load, various fragmentation thresholds (256 bytes, 16 bytes, or no fragmentation limit) have no signification on WLAN throughput when Figure 14 and shows that fragmentations enhance the throughput in case of heavy load. Figure 15 shows a very bad and data rates various from (2Mbps) to (11 Mbps). Figure 9 presents the average delay for the same scenarios; we can be noticed that the fragmentations increases the delay especially the small fragmentation threshold (16 byte). And this increase in delay due to fragmentation is more in the lower data rates (2Mbps) than it is in the high data rates (11Mbps).

Figure 10 and 11 presents the average throughput in case of (10 nodes); we can be observed that the average throughput increases as the number of nodes goes up. This can be validated easily as more nodes mean more traffic which in turn increases the throughput as long as the network connection capacity has not been exceeded.

Figure 12 shows that RTS enhances the performance as most of the best throughputs are under the RTS small (16 byte), while the without RTS and RTS big (256 byte) results were close to each other. This can be validated as RTS is a collision avoidance mechanism for DCF method. Considering the change in delay against the RTS threshold applied as illustrated in From Figure13, we can notice that the using RTS increases the delay especially the big RTS threshold (256 byte). And this increase in delay due to using RTS is more in the lower data rates (2Mbps) than it is in the high data rates (11Mbps). This indicates that it is not recommended to use DCF with data rates 2 or 11Mbps for multimedia applications as the number of generated traffic packets becomes more than what can be handled. Thus the buffer becomes full and the number of dropped packets increases exponentially. Figure 16 Shows that signification enhancement for RTS to performance under heavy load condition.

To validate the simulation results, we have compared results with the 802.11 DCF numerical results obtained in [5].

The values of the parameters used to obtain numerical results for this analytical model, are DSSS parameters which same specified for our simulation. The numerical results of this study show that, for a given number of stations, the throughput increases as the average message length increases. and the best choice is to apply the RTS/CTS access method only for the long messages. Finally, the Basic Access method is much more affected by the number of stations in the network than the RTS/CTS access method. Most of these results match well with our simulation results.

**Conclusions:**

A simulation study of an IEEE 802.11b wireless LAN was presented. The simulations, conducted using OPNET IT Guru Academic Edition 9.1. The simulation results show that:

- DCF with data rates 2 or 11Mbps is not recommended to use multimedia applications as the number of generated traffic packets becomes more than what can be handled. Thus the buffer becomes full and the number of dropped packets increases exponentially.
- The fragmentation threshold and RTS threshold must be tuned according to the load, number of nodes, and bit error rate of the network. Since small fragmentation threshold degrades the performance in the DCF with heavy load, and low bit error rate conditions

**References**

[1] B.H. Walke, S.Mangold and L.Berlemann, "IEEE 802 Wireless Systems Protocols, Multi-hop Mesh/Relaying, Performance and Spectrum Coexistence," John Wiley & Sons Ltd, England, 2006.

[2] S.Rackley, "Wireless Networking Technology from Principles to Successful Implementation," Jordan Hill, 2007.

[3] G. Bianchi, "Performance analysis of the IEEE 802.11 distributed coordination function," IEEE Journal of Selected Areas in Telecommunications, Wireless series, vol. 18, pp. 535–547, Mar. 2000.

[4] A. Vasan and A. U. Shankar, "An empirical characterization of instantaneous throughput in 802.11b WLANs," Technical Report CS-TR-4389, UMIACS-TR, 2002.

[5] R. Bruno, M. Conti and E. Gregori, "IEEE 802.11 Optimal Performances: RTS/CTS Mechanism vs. Basic Access," IEEE Aerospace Conference, 2002.

[6] D. K. Borah, A. Daga, G. R. Lovelace and P. DeLeon, "Performance Evaluation of the IEEE 802.11a and b WLAN Physical Layer on the Martian Surface," IEEE Aerospace Conference, 2005.

[7] Y. Chetoui and N. Bouabdallah, "Adjustment mechanism for the IEEE 802.11 contention window: An efficient

bandwidth sharing scheme," Computer Communications Journal, Vol.30, No.13, p.p 2686–2695, 2007.

[8] C.Siva and B.S.Manoj, "Ad Hoc Wireless Networks Architectures and Protocols," Prentice Hall Communications Engineering, 2005.

[9] Jochen H.Schiller, "Mobile Communication," 2nd Edition, Addison Wesley, 2003.

[10] OPNET Technologies, <http://www.OPNET.com>.

**Table 1: DSSS PHY characteristics**

Characteristic	Value
Slot Time	20 μs
SIFS Time	10 μs
PIFS Time	30 μs
DIFS Time	50 μs
Preamble Length	144 μs
PLCP Header Length	48 μs
CWmin	31
CWmax	1023

**Table 2: Effect of FTS Simulated Scenarios**

No. of node & data rate	FTS. None		
	RTS. None	RTS. 256	RTS. 16
2MS & 2Mbps	Scenario 13	Scenario 14	Scenario 15
2MS & 1Mbps	Scenario 16	Scenario 17	Scenario 18
10MS & 2Mbps	Scenario 19	Scenario 20	Scenario 21
10MS & 1Mbps	Scenario 22	Scenario 23	Scenario 24

**Table 3: Effect of RTS threshold Simulated Scenarios**

No. of nodes & data rate	RTS. None		
	RTS. None	RTS. 256	RTS. 16
2MS& 2Mbps	Scenario 1	Scenario 2	Scenario 3
2MS& 1Mbps	Scenario 4	Scenario 5	Scenario 6
10MS& 2Mbps	Scenario 7	Scenario 8	Scenario 9
10MS& 1Mbps	Scenario 10	Scenario 11	Scenario 12

**Figure 2: two-way handshaking**

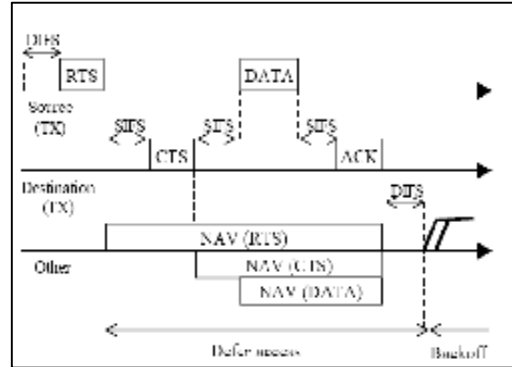

**Figure 1: IEEE 802.11 reference model and the OSI reference model**

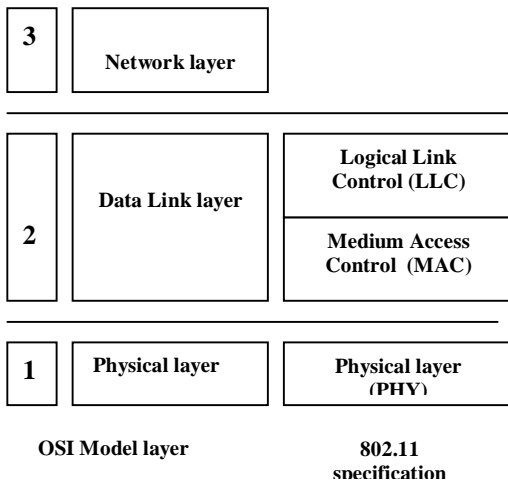

**Figure 3: four-way handshaking**

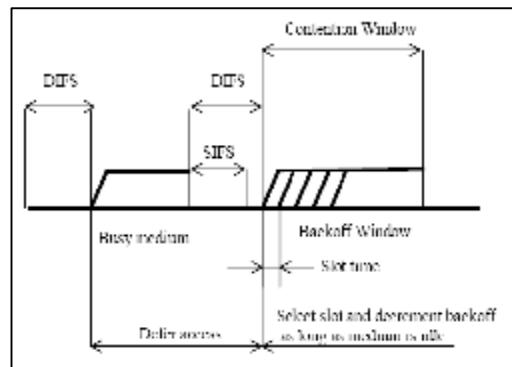

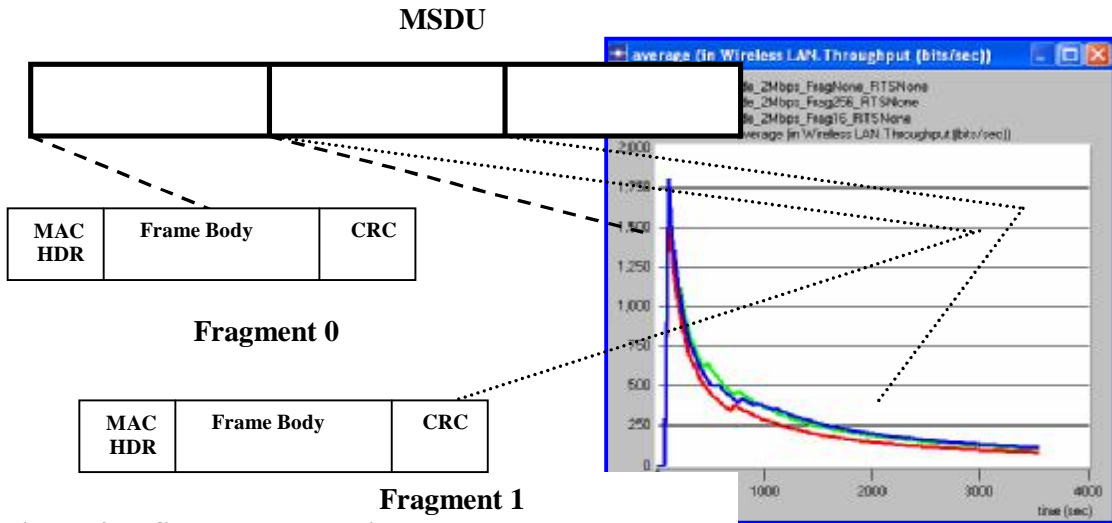

Figure 4: MSDU Fragmentation

Figure 7: Average throughput with FTS

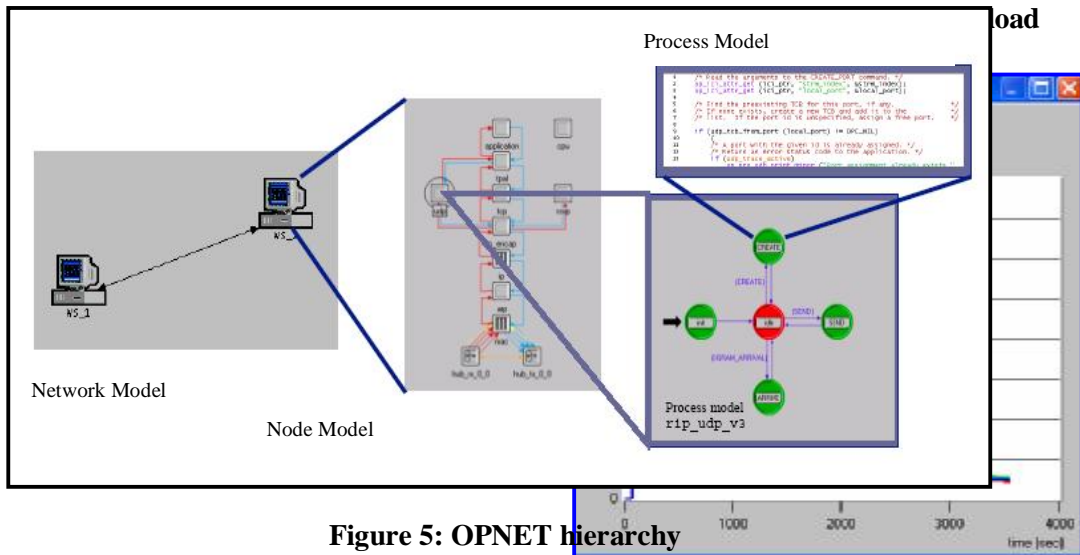

Figure 5: OPNET hierarchy

Figure 8: Average throughput with FTS

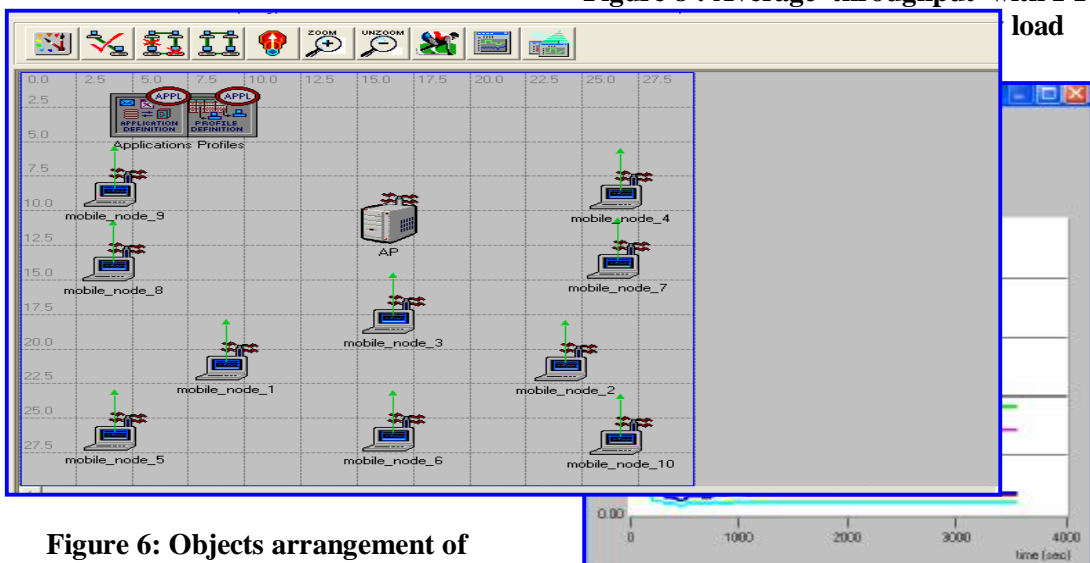

Figure 6: Objects arrangement of DCF project (10 nodes).

Figure 9: Average delay with FTS when data rates 2and11Mbps Low load



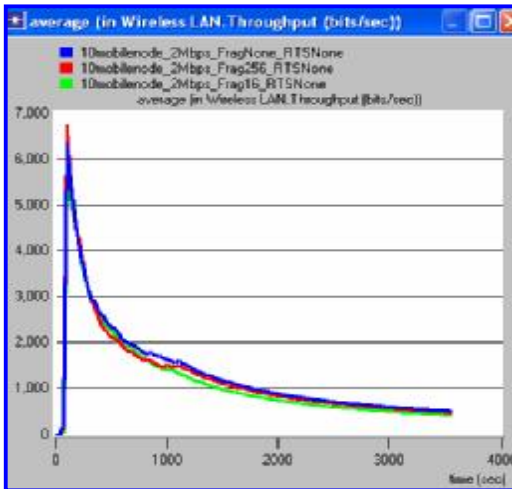

Figure 10: Average throughput of 10 nodes and 2Mbps, low load

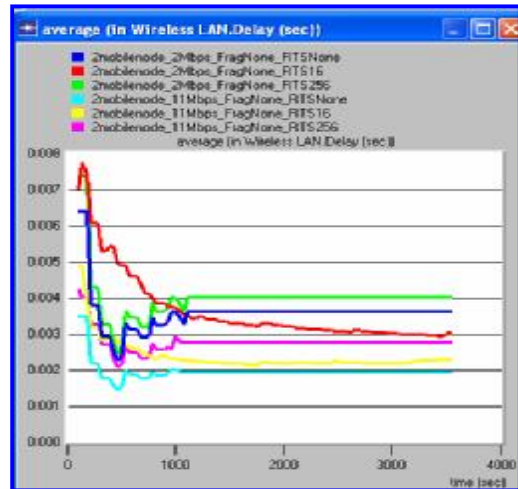

Figure 13: Average delay with RTS low load

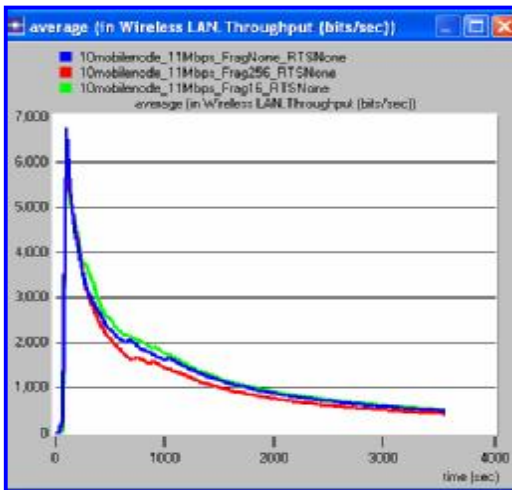

Figure 11: Average throughput of 10 nodes and 11Mbps, low load

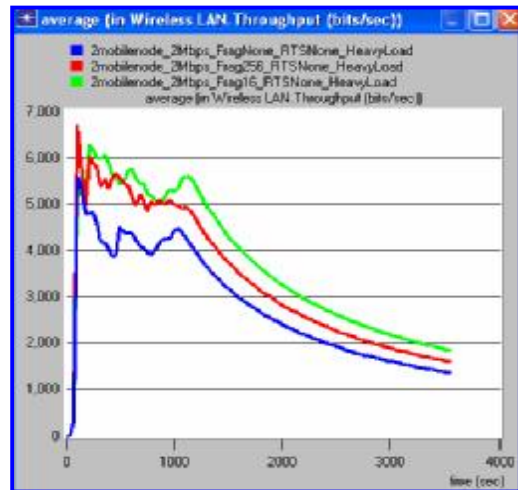

Figure 14: Average throughput with FTS, 2Mbps heavy load

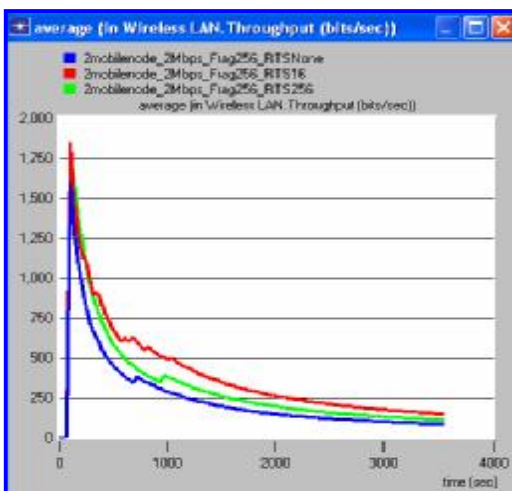

Figure 12: Average throughput with RTS when data rate 2 Mbps low load

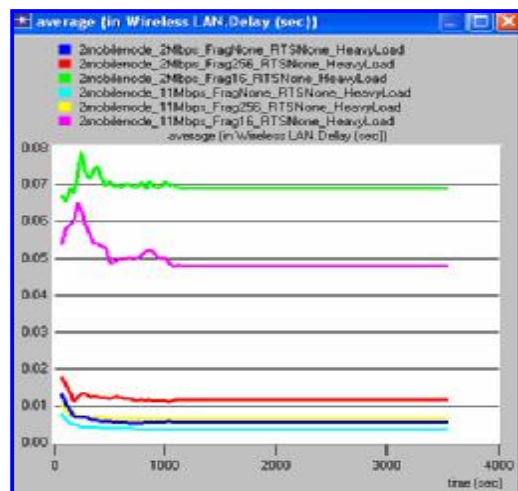
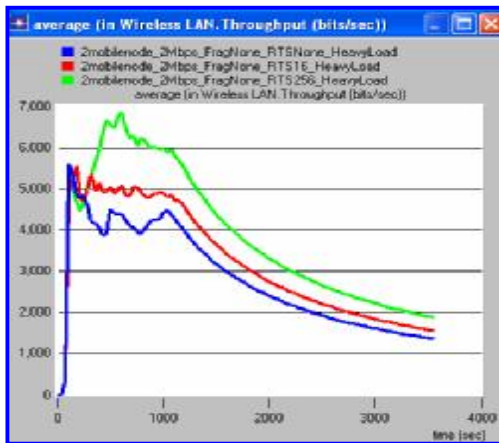

Figure 15: Average delay with FTS heavy load 2 and 11Mbps



**Figure 16: Average throughput with RTS when data rate Mbps heavy load**