

## Design and Implementation of Adaptive Modulation Modem Based on Software Defined Radio(SDR) for WiMAX System

Dr. H. T. Ziboon \* & Zeinah Tariq Naif \*

Received on: 22/11/2009

Accepted on: 1/4/2010

### Abstract

This paper presents design and implementation of adaptive modulation modem for WiMAX system. (BPSK, QPSK, 8QAM, 16QAM, 32QAM and 64QAM) are used in this work. Software Defined Radio(SDR) is used for implementing this modem. This work examines the benefits of using adaptive modulation in terms of probability of bit error and spectral efficiency. It specifically examines the performance enhancement made possible by using linear prediction along with channel estimation in conjunction with adaptive modulation. Simulation results proved that the adaptive system performance with estimator and predictor is better than other modulation alone. The simulation results for adaptive modulation in compared to each modulation technique alone show that for  $BER=10^{-3}$  with ( $f_d=50\text{Hz}-200\text{Hz}$ ) system the improvement occurs by decreasing S/N by 2-3dB. As for  $BER=10^{-4}$  with same Doppler frequency, the system improvement takes place by decreasing S/N by 1.3dB- 4dB. Regarding  $BER=10^{-5}$  with same Doppler frequency, the improvement is by decreasing S/N by 1.5dB-5 dB. Simulation results also show the flexibility of the adaptive system to operate with different level of modulation based on switching of S/N. Matlab7.8(R2009a) used for simulation of adaptive modulation system with AWGN and fading channel.

**Keywords:** SDR, Adaptive modulation, Linear prediction, Estimation of SNR, Fading.

تصميم وبناء مضمن وكاشف ذو سرعة إرسال ونوع تضمين متغير باستخدام  
البرامجيات المعرفة راديويًا

### الخلاصة

يتضمن هذا البحث تحليل وتصميم وبناء مضمن وكاشف متغير التضمين لمنظومة WiMAX. تم استخدام (BPSK, QPSK, 8QAM, 16QAM, 32QAM, 64QAM) والبرامجيات المعرفة راديويًا في هذا العمل. تضمن هذا البحث تفحص فوائد استخدام التضمين المتكيف من خلال قياس الكفاءة الطيفية واحتمالية الخطأ في المعلومات وبالأخص تفحص مقدار التحسن في أداء المنظومة عند استخدام المقدر والمتنبأ وربطهما مع التضمين

المتكيف. أثبتت المحاكاة أن أداء منظومة التضمين المتكيف مع المقدر والمتنبأ أفضل من أداء كل نوع تضمين على حدة. أظهرت نتائج المحاكاة عند مقارنة أداء المضمن مع كل نوع من أنواع التضمين لمفرده حيث تم الحصول على تقليل نسبة الإشارة إلى الضوضاء بوجود الخفوت وتتردد دوبري (50Hz - 200Hz) بمقدار (2dB-3dB) لنسبة خطأ  $(BER) = 10^{-3}$  وبمقدار (1.3dB-4dB) لنسبة خطأ  $(BER) = 10^{-4}$  وبمقدار (1.5dB-5dB) لنسبة خطأ  $(BER) = 10^{-5}$ . وكذلك أظهرت المحاكاة مرونة منظومة التضمين المتكيف بعمله مع عدة مستويات من التضمين بالاعتماد على تحول نسبة الإشارة إلى الضوضاء. تم استخدام Matlab7.8(R2009a) في عملية محاكاة التضمين المتكيف بوجود الضوضاء والخفوت.

## 1. Introduction

Wireless communications has been one of the fastest growing segments in the telecommunications industry. The various advantages of 3G over 2G such as higher data rate as well as increased system capacity have been major motivations to move to 3G[1]. It is well known that the fundamental limitation of wireless systems is constituted by their time-variant channel fading, which results in dramatic fluctuations in signal to noise ratio (SNR). The traditional wireless systems are designed to provide good transmission quality for the worst channel conditions. As a result, signal to noise ratio that are much larger than the target are achieved over a large portion of the coverage area and transmission time, which leads to inefficient utilization of the full channel capacity. In addition, the integration of the voice and data transmission has caused different quality of service requirements over wireless

systems[2]. Adaptive modulation is used to overcome these limitations, where the modulation level, coding rate, and other signal transmission parameters are dynamically adapted to the changing channel conditions without sacrificing the probability of bit error which have recently emerged as powerful tools for increasing the data rate and spectral efficiency and have attracted considerable research interests in the past decades [3]. Adaptive modulation can increase average throughput, reduce required transmit power, or reduce average probability of bit error by taking advantages of favorable channel conditions to send at higher data rates, at lower power and reducing the data rate as increasing power as the channel degrades[4]. To implement such flexible adaptive modulation processor, the Software Defined Radio (SDR) technique is used. SDR is a highly configurable hardware platform that provides the technology for realizing the rapidly expanding

third and fourth generation digital wireless communication infrastructure[5]. The software radio technique allows to describe radio functionalities defined by software. The possibility to define the typical functionalities of a radio interface by software will be an excellent opportunity to improve system performance[6].

2. Adaptation Boundaries

The first step in adaptive modulation modem is to define a way to select which modulation scheme is best suited for the present (or future in the case of delayed feedback). SNR at receiver is used[7] as a good channel metric to decide the selection(or switching) of the modulation scheme. The ranges of S/N (in the receiver) will be used to select modulation scheme (in the transmitter) based on AWGN performance for each modulation scheme. Figure(1) shows the typical BER variation with (S/N) for different modulation schemes BPSK, QPSK, 8QAM, 16QAM,32QAM and64QAM[8].

The probability of bit error rate for different schemes of modulation are given by [9]:

$$P_{bBPSK} = Q\sqrt{2\gamma} \dots(1)$$

$$P_{bQPSK} = Q\sqrt{2\gamma} \dots(2)$$

$$P_{bMQAM} = \frac{2(\sqrt{M}-1)}{\sqrt{M \log_2 M}} Q\left(\sqrt{\frac{3\gamma \log_2 M}{(M-1)}}\right) \dots(3)$$

where:

$\gamma$  =is signal-to -noise ratio

$Q$  = complementary error function

M is order of modulation.

The Probability Density Function (PDF) of the fluctuations in instantaneous received power  $x$ , in a Rayleigh channel is given by[7]:

$$F(x, X) = \frac{2\sqrt{x}}{X} \exp\left(-\frac{x}{X}\right) \dots(4)$$

where:

X is average signal power. For any modulation scheme if  $P_G(S/N)$  is the Gaussian BER performance, then the upper bound for the BER performance in a Rayleigh channel is given by[8]:

$$P_r\left(\frac{S}{N}\right) = \int_0^\infty P_G\left(\frac{S}{N}\right) \cdot F(x, X) dx \dots(5)$$

Therefore the upper bound BER performance of an adaptive modulated signal may be computed from:

$$P_a\left(\frac{S}{N}\right) = \frac{1}{E} \left[ \int_{I_1}^{I_2} P_{BPSK}\left(\frac{S}{N}\right) \cdot F(x, X) dx + \int_{I_2}^{I_3} P_{QPSK}(N) \cdot F(x, X) dx + \int_{I_3}^{I_4} P_{8QAM}(S/N) \cdot F(x, X) dx + \int_{I_4}^{I_5} P_{16QAM}(S/N) \cdot F(x, X) dx + \int_{I_5}^{I_6} P_{32QAM}(S/N) \cdot F(x, X) dx + \int_{I_6}^{I_7} P_{64QAM}(SN) \cdot F(x, X) dx \right] \dots(6)$$

where:

$l_1, l_2, l_3, l_4, l_5, l_6, l_7$  are the thresholds between transmission of QPSK, 8QAM, 16QAM, 32QAM and 64QAM. The throughput of the adaptive modulation B is given by[7]:

$$B = \int_{l_1}^{l_2} F(x, X) dx + 2 \int_{l_2}^{l_3} F(x, X) dx + 3 \int_{l_3}^{l_4} F(x, X) dx + 4 \int_{l_4}^{l_5} F(x, X) dx + 5 \int_{l_5}^{l_6} F(x, X) dx + 6 \int_{l_6}^{l_7} F(x, X) dx \dots\dots(7)$$

where:

B is spectral efficiency of adaptive modulation.

The BER performance of equation(7) is simulated with switching levels shown in Table(1) for **BER**  $10^{-3}, 10^{-4}, 10^{-5}$ .

**3.SNR Estimation**

There are several methods to estimate signal to noise power ratio[10]. The purpose of measuring SNR is to get a more accurate view of the channel state. The received and demodulated signal will be corrupted by both the Rayleigh channel and receiver noise (whose statistics do not change over short intervals). In general the Rayleigh fluctuations are too quick to use for the adaptation, so the goal is to track (and adapt to) shadow fading while averaging out the Rayleigh fading[11]. The SNR measurement approach is shown in Figure(2). The received signal is passed through a square-law envelope detector and then amplified using a linear or log amplifier[10]. Consider both types of amplifiers, since the

statistics of the Rayleigh fading are simpler for a linear amplifier, while the statistics of the log-normal fading are simpler for a log amplifier

**4.Channel Prediction**

Adaptive modulation methods depend on accurate channel state information (CSI) that can be estimated at the receiver and sent to the transmitter via a feedback channel[12]. This information would allow the transmitter to choose the appropriate transmitted signal. The feedback delay and overhead, processing delay and practical constraints on modulation switching rates have to be taken into account in the performance analysis of adaptive modulation methods. For very slowly fading channel, CSI is sufficient for reliable adaptive system design. However, for rapidly time variant fading that corresponds to realistic mobile speeds, even small delay will cause significant degradation of performance since channel variation due to large Doppler shifts usually results in a different channel at the time of transmission than at the time of channel estimation [2]. To realize the potential of adaptive transmission methods, the channel state information (CSI) is obtained by channel prediction[13].

The idea behind channel prediction is to use past and present channel samples to predict future samples. The implementation of prediction scheme is for specific purpose to expect the future power level of the Rayleigh channel[14]. Linear predictor is shown in figure(3). Linear prediction is concerned with estimation of the next sample in terms

of a linear combination of the current and previous samples. FIR linear predictor of order p-1 is given by[15]:

$$\hat{c}_n = \sum_{j=0}^{p-1} q_j c_{n-j} \quad j = 0, 1, \dots, p - 1 \quad \dots\dots(8)$$

where:

$q_j$  are the linear prediction filter coefficients,  $p$  is filter length.  $\hat{c}_n$  is a predicted value based on combination of  $p$  previous observation  $c_{n-1}, \dots, c_{n-p}$ .

5. Description of system model

Figure(4) shows the general layout of the proposed system. Figure(5)represents the flow chart of the designed system. The main parts of the implemented proposed system are:-

1. Transmitter: The transmitter is responsible for:
  - a. Generating the symbols of the transmitted data which is transmitted over a wireless channel.
  - b. Selecting modulation schemes based on S/N(which is estimated in the receiver). The modulation schemes used in the proposed system are BPSK,QPSK, 4QAM,8QAM,16QAM,32QAM,64QAM.
2. Channel: Mobile wireless channel with AWGN and Rayleigh fading are used in simulation.

3. Receiver which is responsible for data reception and demodulation of the received data. Once, the data has been demodulated, an estimate and prediction of the received S/N then feedback to the transmitter via the feedback loop.

The design parameters of the system are shown in table(2).

6. Description of the Designed system components

6.1 Design of Digital Arm Filter

The digital arm filter is designed by using the hamming window for simplicity in designing filters for I and Q channel. Lowpass filter is used in order to remove the high frequency components from the output of multiplier. The two digital arm filters in receiver must have the same design to avoid jitter and the order is not too high because that means delay. This filter will be FIR filter because it has linear frequency response. This means no phase distortion is introduced into the signal by the filter[15]. Table(3) shows the parameters selected for the filter.

The transfer function is given by:

$$H(z) = \sum_{n=0}^{N-1} h(n) z^{-n} \quad \dots\dots(9)$$

The hamming window is given by[16]:

$$w(n) = 0.54 + 0.46 \cos\left(\frac{2\pi n}{M}\right) \dots(10)$$

where:  
 $n = 0, 1, 2, \dots, M - 1$ .  $w(n)$  is the window function,  $h_D(n)$  is the desired impulse response of the filter,  $f_c$  is chosen proportional to sampling rate,  $M$  is the filter order.

**6.2 Design of Estimation Circuit**

The first stage of estimation circuit is square low envelop detector as shown in Figure(2). Squaring the signal effectively demodulates the input signal by using itself as the carrier wave. The envelope can then be extracted by keeping all the DC low-frequency energy and eliminating the high-frequency energy. The second stage of estimation circuit is amplifier(linear or non linear).

The third stage is RC low pass filter whose cutoff frequency will be very small in order to produce the DC level. The type of selected modulation is based on the value of SNR estimated by this estimator. The output of estimation unit is given by:

$$v_o = x^2 \cdot [A] \cdot [H_{RC}] \dots(11)$$

where:

$v_o$  is the output voltage level,  $x$  is the square input signal,  $A$  is the gain

of amplifier and  $H_{RC}$  is the transfer function of the feedback loop digital filter. Table(4) shows the parameters selected for the estimation circuit.

**6.3 Linear predictor**

Linear predictor is used to predict the current value of the signal based on the past samples. Linear predictor is selected to reduce the delay time taken for estimation and time required to return the estimation value to the transmitter[9]. The predict signal is given by[15]:

$$\hat{x}(n + 1) = \sum_{k=0}^{p-1} w(k)x(n - k) \dots( 12)$$

where:

$w(k)$  for  $k = 0, 1, 2, \dots, p - 1$  are the coefficients of the prediction(FIR) filter, and  $p$  is prediction order.

$$r_{dx} = R_x * w \dots(13)$$

where:

$w$  is the vector of filter coefficients ,  $R_x$  is  $p \times p$  matrix of autocorrelation, and  $r_{dx}$  is the vector of cross-correlation between desired signal and the observed signal. The value of  $r_{dx}$  is given by Wiener-Hopf equations [15]:

$$r_{dx} = r_x(k+1)$$

.....(14)

## 7. Simulation results

### 7.1 BPSK system simulation results

Figures(6,7) show the performance of BPSK system over AWGN and Rayleigh fading evaluated by plotting the Bit error rate(BER) versus the (S/N) .

### 7.2 QPSK system simulation results

The performance of QPSK system will be evaluated by plotting the Bit error rate(BER) versus the (SNR). Figure(8) shows the performance simulation of QPSK over AWGN. Figure(9) shows the simulation performance of QPSK over Rayleigh fading.

### 7.3 M-QAM system simulation results

The performance of M-QAM system will be evaluated by plotting the Bit error rate(BER) versus the (SNR) in the presence of AWGN and Rayleigh fading for different values of Doppler frequency. Figures(10,11,12,13,14,15,16,17) show the performance of 8QAM, 16QAM, 32QAM and 64QAM over AWGN and Rayleigh fading.

## 7.4 Simulation results of Adaptive

modulation with estimation and prediction Figures(18,19,20,21,22,23) show the results of bit error rate versus SNR for (BPSK, QPSK, 8QAM, 16QAM, 32QAM, 64QAM) system respectively where estimation and prediction are used. These results show the effectiveness of estimator and predictor to improve the results by degrading the required SNR for a given BER. Figures(24,25,26) show the variation of spectral efficiency of adaptive modulation with estimation and prediction for different values of BER ( $10^{-3}, 10^{-4}, 10^{-5}$ ). Simulation results coincide with the theoretical results since the required BER is a fixed value in channel and ideal estimation in order to control switch level of SNR.

### 7.5 Discussion of simulation results

1. Adaptive modulation improved the power spectral efficiency if compared with uniform modulation for specified parameters. The simulated curves coincide well with the theoretical curves for different Doppler rates attributed to the presence of estimator and predictor so good spectral efficiency curves will be obtained.
2. Doppler frequency reduces the system performance especially at high values either with modulations alone or with adaptive modulation and suffer losses in BER. This leads to use prediction.
3. Prediction improves the system performance as compared with system without prediction but prediction is not affected too much at very high Doppler frequency but system



performance with prediction is better than without prediction.

4. Finally, the results obtained from the simulation prove that adaptive modulation system was operated with high accuracy and stable performance

### 8. Conclusions

The following points represent the main conclusions obtained from this work:-

1. The use of adaptive modulation allows a wireless system to choose the highest order modulation depending on the SNR. Different order modulations allow to send more bit per symbol and thus achieve higher data rate and better spectral efficiency.

2. Adaptive modulation is suggested for WiMAX system due to its capability to satisfy the WiMAX requirements.

3. Simulation results show that in the presence of fading, the system degrades by 20dB for given BER if compared to presence of AWGN. However, this degradation in system efficiency can be improved by using adaptive modulation and keep BER in the same level by selecting different modulation (based on SNR estimation for pre-defined target BER).

4. Channel estimation with prediction will improve the performance of adaptive modulation. The system for BER  $10^{-4}$  will be improved by 2dB if compared with system without estimation.

5. The system performance can be improved by adding linear prediction to avoid delay which is caused by time to estimate the SNR of the received signal and the time required to return the estimated value to transmitter.

6. Simulation results show that as Doppler frequency increased up to 200Hz system, performance decreased the required SNR by 1.5dB for BER  $10^{-3}$  and 1dB for BER  $10^{-4}$  and 1.5dB for BER  $10^{-5}$  if compared with system performance without estimator and predictor.

7. Implementing this system by SDR provides more flexibility with lower cost and time. The work can be extended by using FPGA with VHDL language to store the software used in this system.

### 9. References:

- [1] Byoung-Jo Choi and Lajos Hanzo, " Optimum Mode-Switching Assisted Adaptive Modulation ", IEEE Transaction on Communication ,vol. 37, No.5, pp. 247-249 ,February 2001.
- [2] T. Nechiporenko, " Cooperative Communication Under Adaptive Transmission", M.Sc thesis, Department of electrical and computer engineering, University of Alberta, 2008.
- [3] ] E.S. Altubaishi, " Average Switching Thresholds and Average



- Throughput for Adaptive Modulation using Markov Model", ISSN Processing and Technology, Volume, 17December 2006.
- [4] A. J. Goldsmith and Soon-Ghee Chua, " Adaptive Coded Modulation for Fading Channels", IEEE Transaction on Communications, vol. 46, No. 9, May 1998.
- [5] John Bard, " Software Defined Radio, the Software Communications Architecture", Space Coast Communication System Inc. Harris Corporation, USA, John Wiely, 2007.
- [6] G. Saver, " Scalable and Reconfiguration Digital Front- End SDR Wideband Channelize", M.Sc thesis, Department of Electrical Engineering, Mathematics and computer Science Delft University, 2006.
- [7]. R. Chan, " Channel Prediction for Adaptive Modulation in Wireless Communication", M.Sc. thesis, Department of Electrical Engineering, Virginia Polytechnic and State University, July 2003.
- [8] X. Tang, M.S. Alouini and A.J. Goldsmith, " Effect of Channel Estimation Error Performance in Rayleigh Fading", IEEE press, vol. 4, no. 23, pp. 7803-7809, November 1999.
- [9] A.J. Goldsmith, " Wireless Communications", Stanford university, Andrea Goldsmith Publishers, 2004.
- [10]. M. Mohammad, R. M. Buehrer, " On the Impact of SNR Estimation Error on Adaptive Modulation", IEEE Communication letters, Vol. 9, NO. 6, June 2005.
- [11] T. Shung Yang, A. D. Hallen, " Reliable Adaptive Modulation Aided by Observations of Anther Fading Channels", IEEE transaction on communications, Vol.52, No.4, 2004
- [12] M. Lei, " Performance Analysis of Reliable Adaptive Transmission for Mobile Radio Slow Frequency Hopping Channels Aided by Long Range Prediction", M.Sc thesis, Department of Electrical Engineering, North Carolina state university, 2004.
- [13] S. Houi, A. D. Hallen, " Combined Adaptive Modulation and Transmitter Diversity Using Long Range Prediction for Flat Fading Mobile Radio Channels", IEEE Transaction on Communications, VOL.50, NO.11, November 2001.
- [14] G. E. Qien, H. Holm, K. J. Hole, " Impact of Channel Prediction on Adaptive Coded Modulation Performance in Rayleigh Fading", IEEE Transaction. Veh. Techno, vol. 5, pp. 713-718, February 2004.
- [15] A. Aguiar, H. Karl, A. Wolisz, H. Miesmer, " A Framework for Evaluating Effect of Channel Prediction Inaccuracy on the Performance of Channel Adaptive Techniques", International Conference on Wireless network-ICW No.3, June 2003.
- [16] M. H. Hayes, " Statistical digital signal processing and Modeling", Georgia Institute of Technology, John Wiely, 1996.

Table (1) Switching threshold levels

Modulation schemes	SNR thresholds in dB		
	BER = 10 <sup>-3</sup>	BER = 10 <sup>-4</sup>	BER = 10 <sup>-5</sup>
BPSK	5 < SNR < 6	6 < SNR < 8	7 < SNR < 9
QPSK	6 ≤ SNR < 11	8 ≤ SNR < 12	9 ≤ SNR < 13
8QAM	11 ≤ SNR < 13	12 ≤ SNR < 14	13 ≤ SNR < 15
16QAM	13 ≤ SNR < 15	14 ≤ SNR < 16	15 ≤ SNR < 17
32QAM	15 ≤ SNR < 17	16 ≤ SNR < 19	17 ≤ SNR < 20
64QAM	SNR ≥ 17	SNR ≥ 19	SNR ≥ 20

Table (2) Design parameters goals

parameter	Selected types or values	comment
Modulation type	BPSK, QPSK, 4QAM,8QAM, 16QAM,32QAM, 64QAM	BPSK and QPSK and MQAM is implemented in this system to increase data rate of transmission
Channel estimator	Circuit contain envelop detector , amplifier, RC filter	Parameters of this circuit is choice to provide the suitable output value that can be used by the normal IF system
IF frequency	10MHz	Moderate frequency can be used to implement SDR system
predicator	Linear prediction	Because its simplicity and efficient method to increase system efficiency.
Sampling frequency	100MHz	This value is selected for better simulation results
Data rate	20MHz	Suitable data rate can be selected for IF
Doppler frequency	100Hz-200 Hz	This value is compatible for WiMAX for f(2.5-2.7)GHz, vehicle speed 200Km/hour

**Table (3) Characteristics of Arm filter**

<b>Filter type</b>	<b>LPF filter is used to remove high frequency components from the output of PDF</b>
<b>Filter character</b>	<b>FIR Because it is a linear phase response, and simple in the design</b>
<b>Bandwidth(BW)</b>	<b>20MHz</b>
<b>Filter window type</b>	<b>Hamming window is used because of its simplicity and for its accuracy</b>
<b>Filter order</b>	<b>15</b>

**Table (4) Characteristics of estimation circuit.**

<b>Envelope detector</b>	<b>Squaring the input signal</b>
<b>amplifier</b>	<b>Linear amplifier with gain=2</b>
<b>RC filter</b>	<b>FIR digital filter with order=10</b>
<b>Bandwidth</b>	<b>100KHz</b>

**Table (5) Characteristics of linear predictor**

<b>Order of predictor</b>	<b>3</b>
<b>The coefficients of the predictor:-</b>	
<b>w(0)</b>	<b>1</b>
<b>w(1)</b>	<b>0.4983</b>
<b>w(2)</b>	<b>0.3287</b>
<b>w(3)</b>	<b>0.220</b>

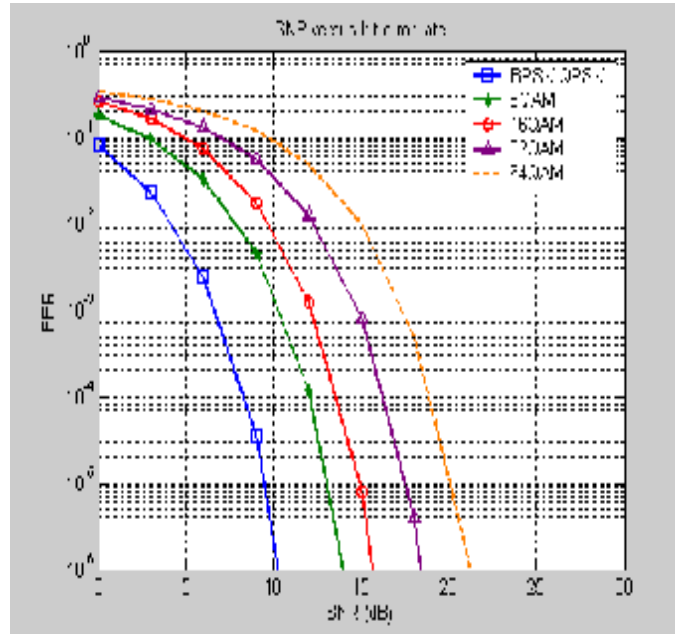

Figure (1) Typical BER variation with (SNR)for different modulation schemes BPSK, QPSK, 4QAM, 8QAM, 16QAM, 32QAM and 64 QAM

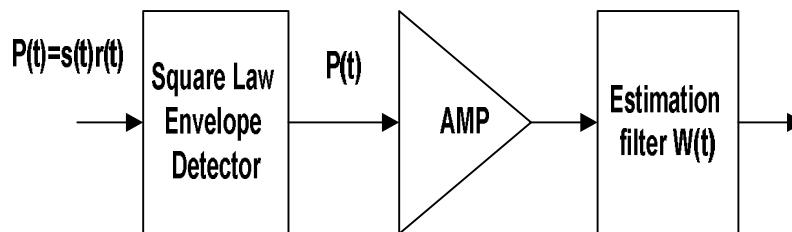

Figure (2) Signal to noise ratio measurement technique

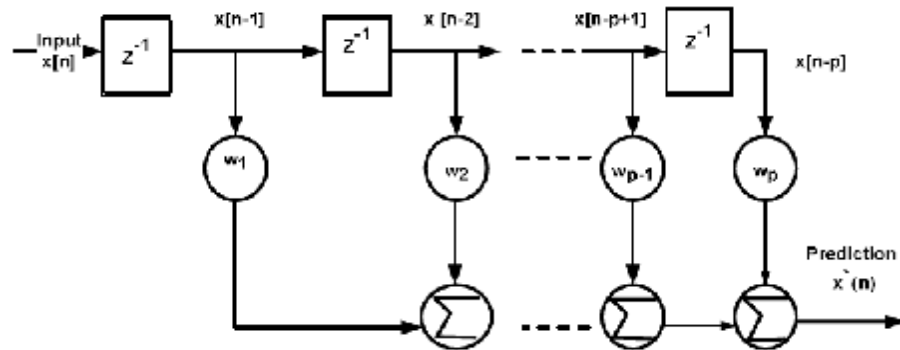

Figure (3) Block diagram of linear prediction filter of order  $p$

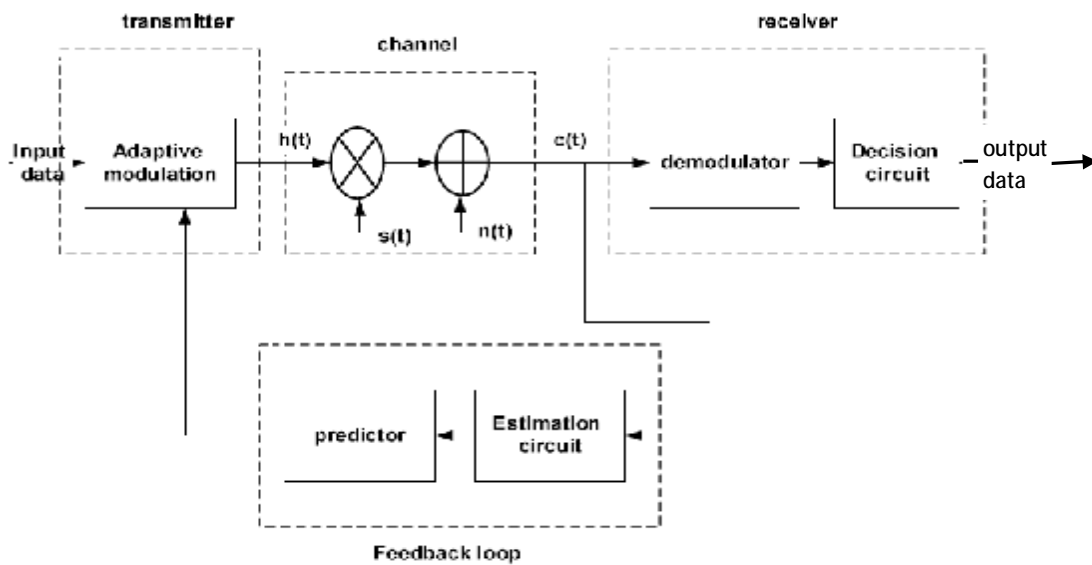

Figure (4) proposed system

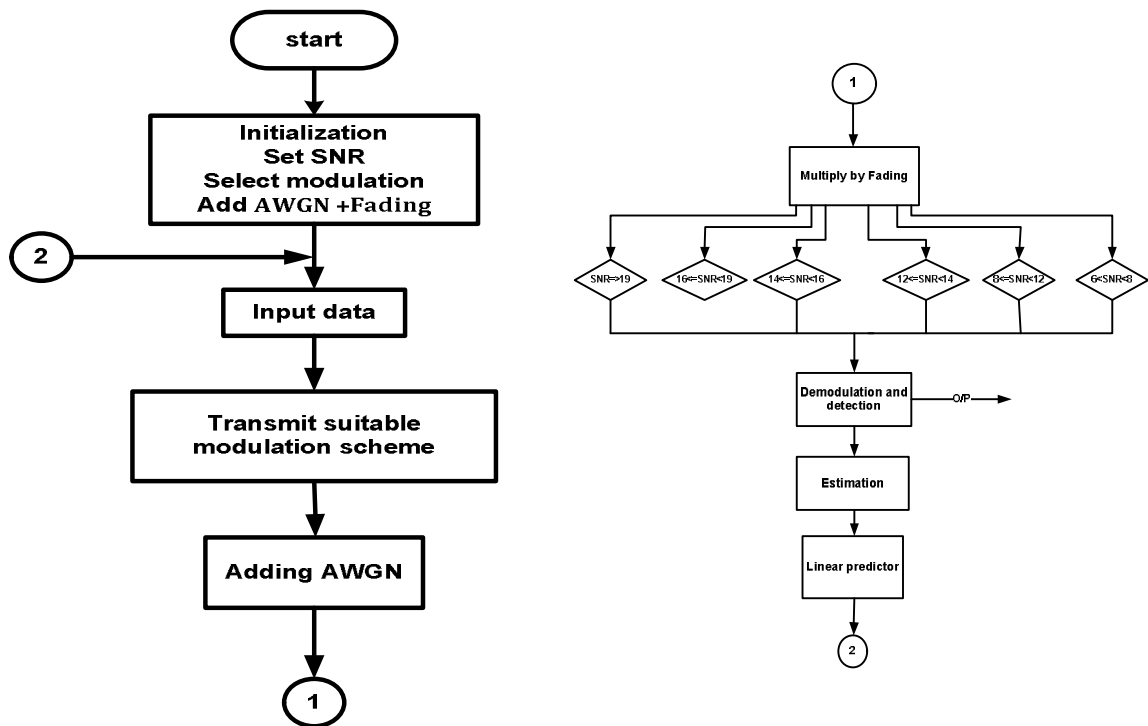

Figure (5) Flow chart of the designed system

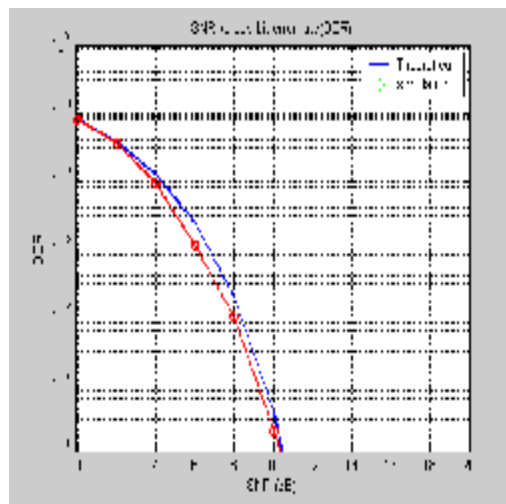

Figure (6) Simulation results of BPSK over AWGN

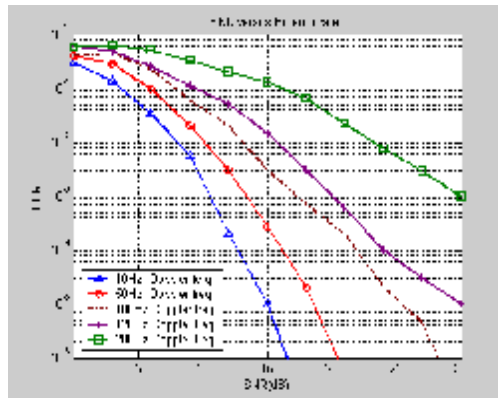

Figure (7) Simulation result of BPSK over Rayleigh fading

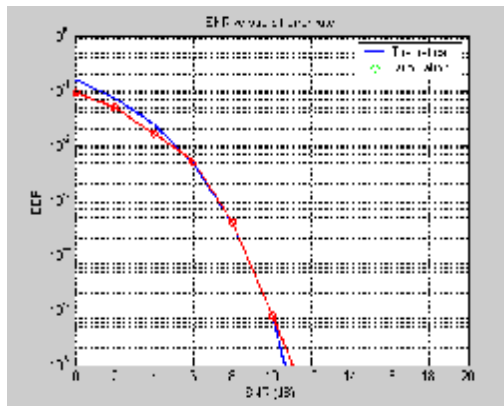

Figure (8) simulation results of QPSK over AWGN.



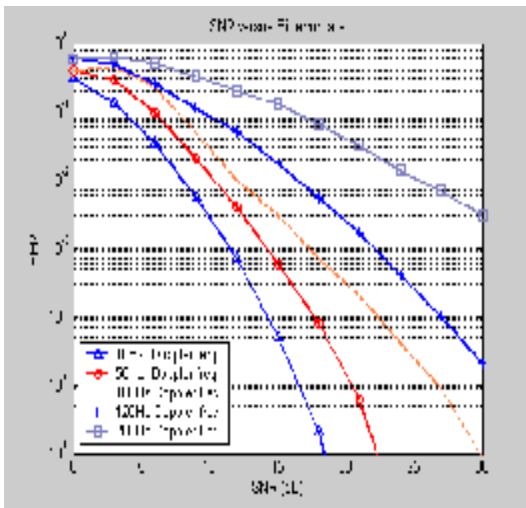

Figure (9) Simulation results of QPSK over Rayleigh fading

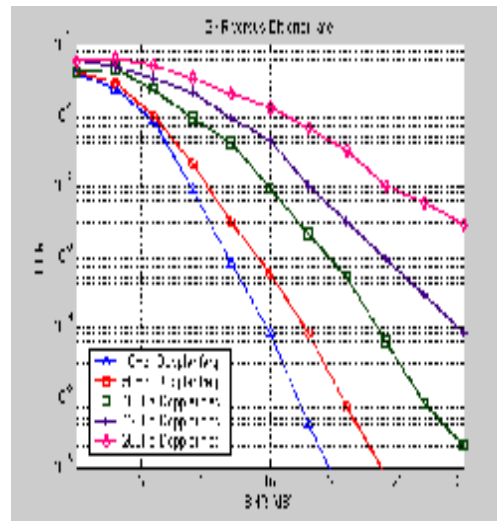

Figure (11) Simulation results of 8QAM over Rayleigh fading

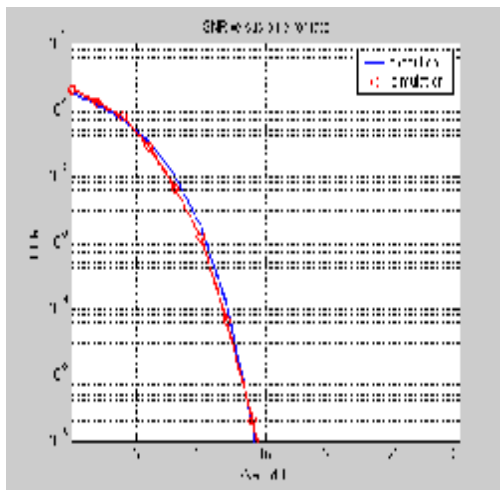

Figure (10) Simulation results of 8QAM over AWGN

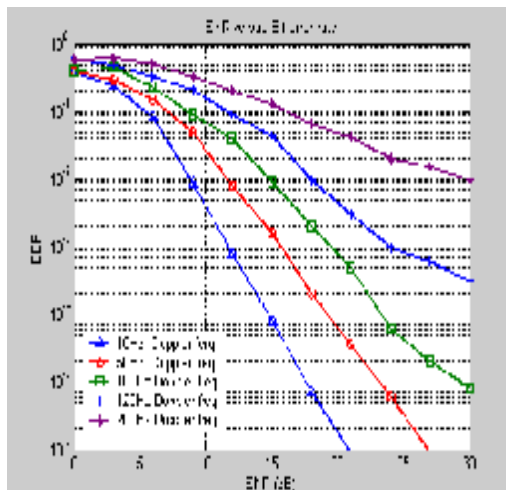

Figure (12) Simulation results of 16QAM over AWGN

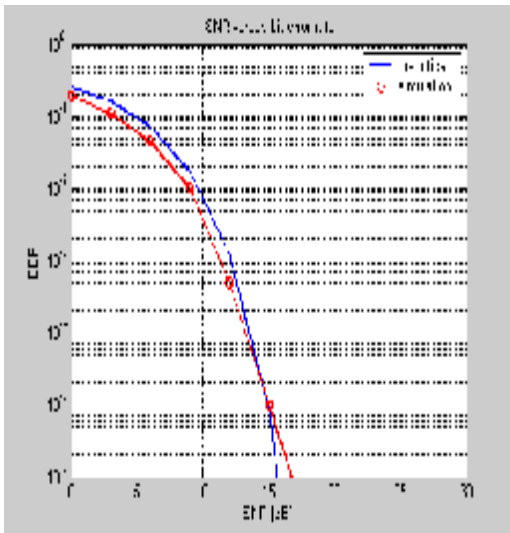

Figure (13) Simulation results of 16QAM over Rayleigh fading

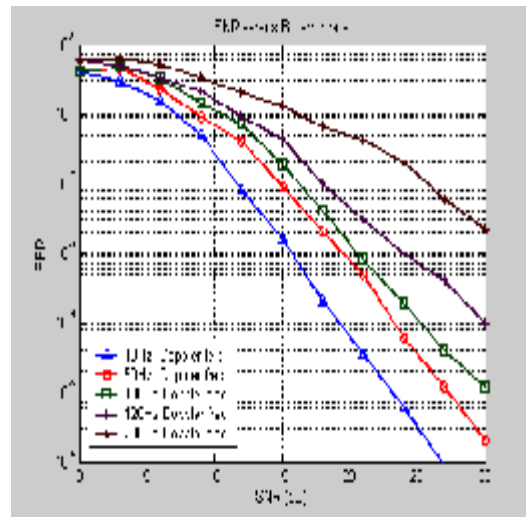

Figure (15) Simulation results of 32QAM over Rayleigh fading

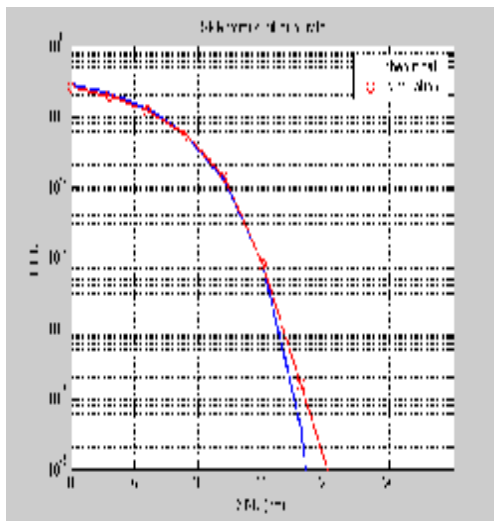

Figure (14) Simulation results of 32QAM over AWGN

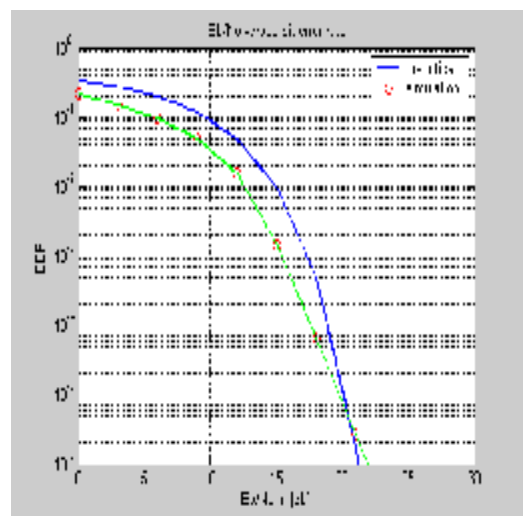

Figure (16) Simulation results of 64QAM over AWGN

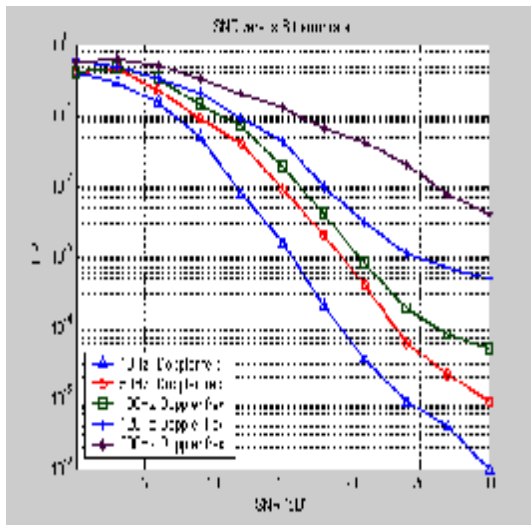

Figure (17) Simulation results of 64QAM over Rayleigh fading

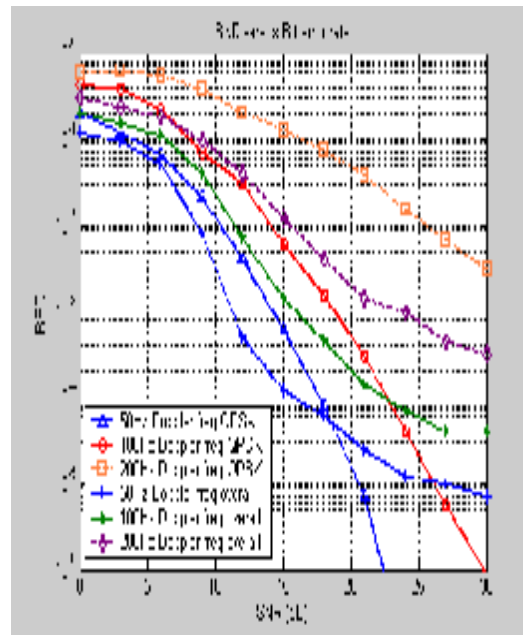

Figure (19) Comparison performance between QPSK and overall system (with estimator and predictor) for different Doppler frequency

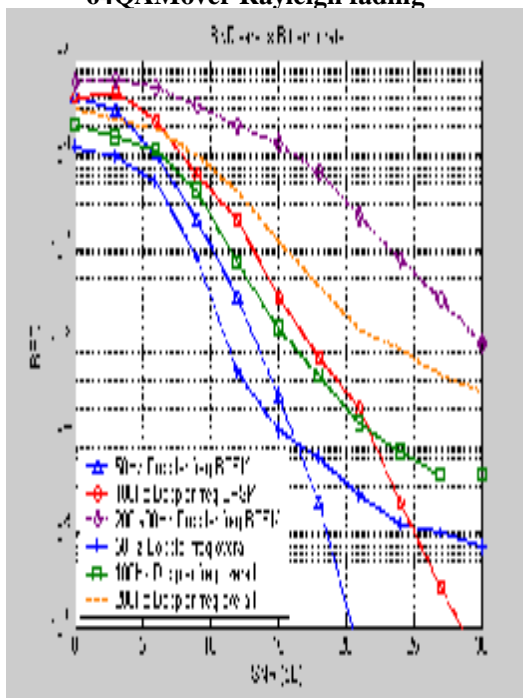

Figure (18) Comparison performance between BPSK and overall system (with estimator and predictor) for different Doppler frequency

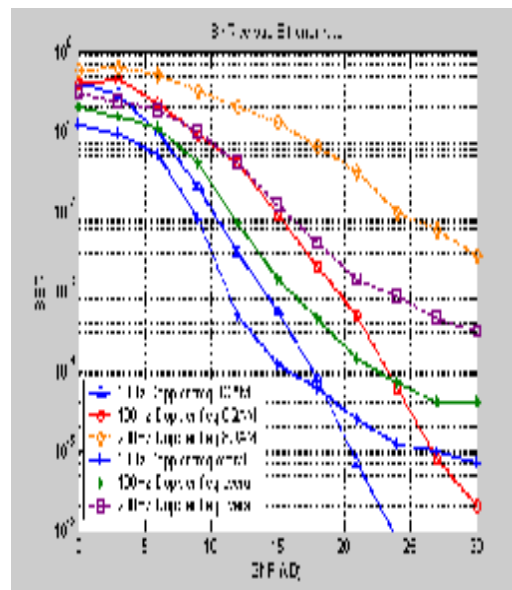

Figure (20) Comparison performance between 8QAM and overall system (with estimator and predictor) for different Doppler frequency

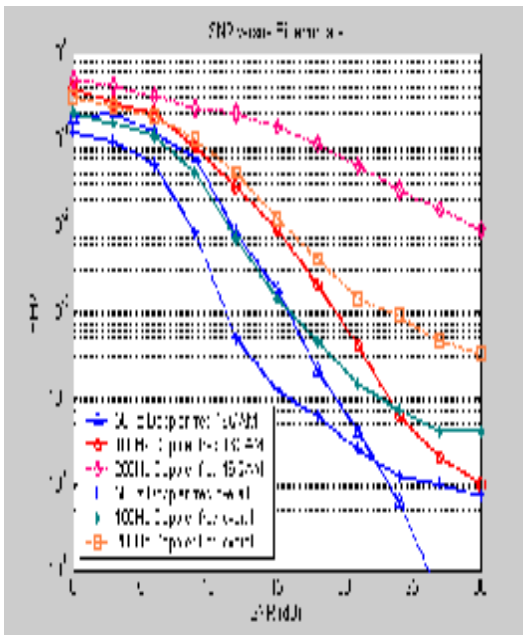

Figure (21) Comparison performance between 16QAM and overall system (with estimator and predictor) for different Doppler frequency

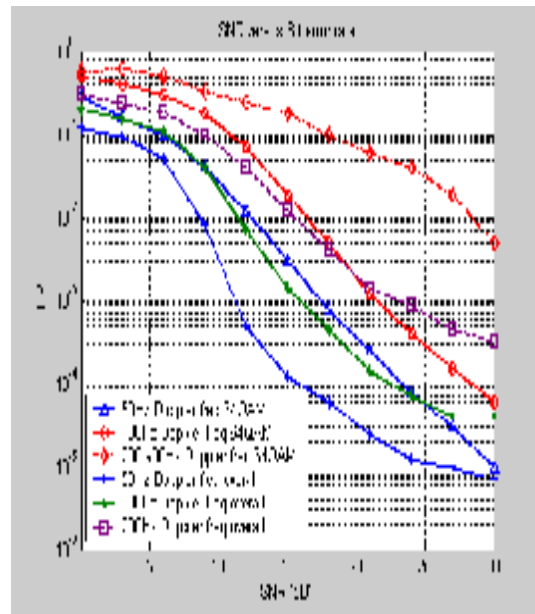

Figure (23) Comparison performance between 64QAM and overall system (with estimator and predictor) for different Doppler frequency

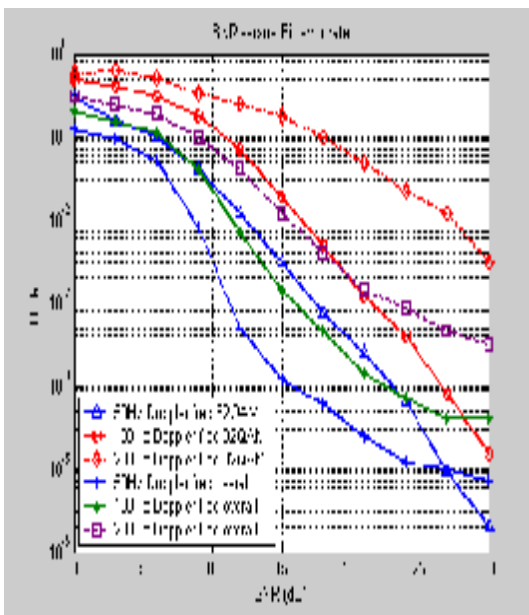

Figure (22) Comparison performance between 32QAM and overall system (with estimator and predictor) for different Doppler frequency

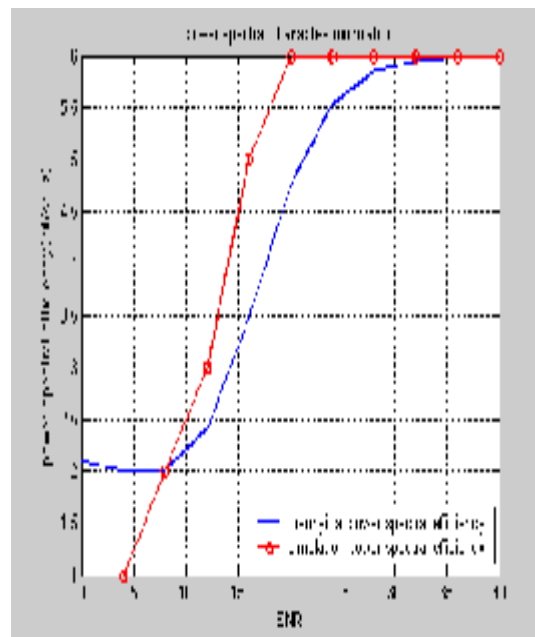

Figure (24) Spectral efficiency of adaptive modulation with estimator and predictor for target BER= $10^{-3}$

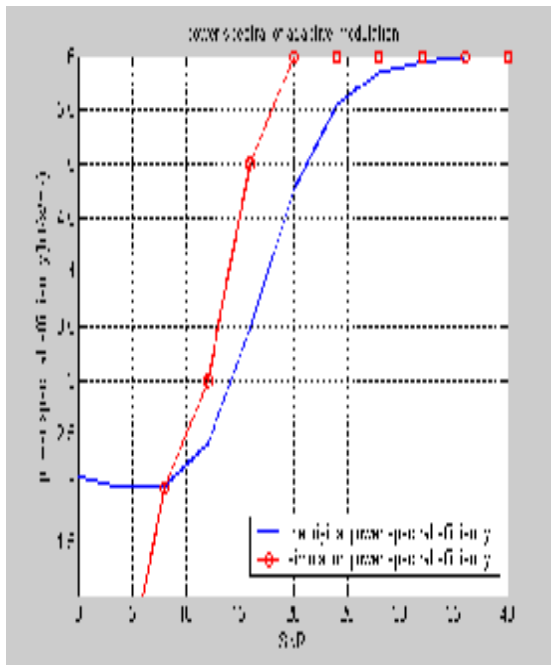

Figure (25) Spectral efficiency of adaptive modulation with estimator and predictor for target BER= $10^{-4}$

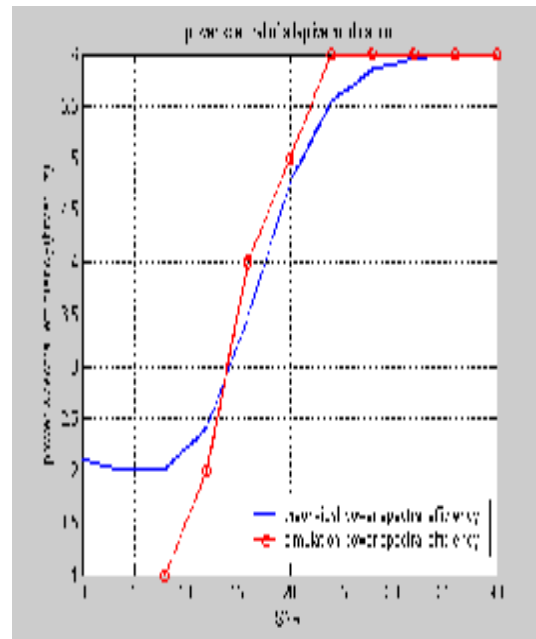

Figure (26) Spectral efficiency of adaptive modulation with estimator and predictor for target BER= $10^{-5}$