

Laser Pulses Effect on the Structural and Optical Properties of ZnO Nan particles Prepared by Laser Ablation in Water

Dr. Evan T. Salim

Applied Science Department, University of Technology/Baghdad

Email: uot_techmagaz@yahoo.com

Halah H. Rashed

Applied Science Department, University of Technology/Baghdad

Received on: 25/4/2012 & Accepted on: 4/7/2013

ABSTRACT

In this work ZnO Nps were fabricated by liquid phase pulse laser ablation (LP-PLA) technique. The experiments were carried out by using the radiation of the pulsed Nd:YAG laser operating at the 1060 nm wavelength, 9 ns pulse duration and 1 Hz repetition rate of Zn plate immersed in DIW water, the effect of laser pulses on the amount of ablated materials, structural, optical and morphology of ZnO Nps has been studied. The atomic absorption result shows that the amount of the ablated material is directly proportional to the number of laser pulses and the atomic force microscope show that the grain size of the obtained NPs are decrease with the number of laser pulses.

The UV-Visible show a blue shift was recognized with a larger number of laser pulses while the photoluminescence result gives a blue shift with the decrease in number of laser pulses

تأثير نبضات الليزر على الخصائص التركيبية و البصرية لجسيمات ZnO النانوية المحضرة بواسطة الإزالة الليزرية في الماء

الخلاصة

في هذا البحث تمت تحضير جسيمات اوكسيد الزنك النانوية باستخدام تقنية الاستئصال بالليزر في الوسط السائل. تمت التقنية بواسطة التشعيع ليزر النديميوم -ياك يعمل بطول موجي 1060 nm و امد نبضة 9 nsec ومعدل تكرار النبضة 1Hz لمعدن الزنك مغمور بالماء المقطر، وتم دراسة تأثير نبضات الليزر على كمية المواد المستأصلة والخصائص التركيبية و البصرية وطبوغرافية السطح لجسيمات ZnO النانوية. حيث أظهرت نتائج الامتصاص الذري أن كمية المادة مستأصلة تتناسب مباشرة مع عدد النبضات الليزر، و نتائج مجهر القوى الذرية بينت أن الحجم الحبيبي للجسيمات النانوية تقل مع زيادة عدد النبضات.

وأظهرت نتائج الخصائص البصرية حدوث إزاحة نحو اللون الأزرق مع زيادة عدد النبضات بينما أظهرت نتائج الانبعاثية الطيفية إزاحة نحو اللون الأزرق مع نقصان في عدد النبضات الليزرية .

INTRODUCTION

Laser ablation is a typical example of top-down approach in fabrication of nanoparticles [1]. Pulsed laser ablation in liquid media (PLAL) is a promising technique for the controlled fabrication of nanoparticles via rapid reactive quenching of ablated species at the interface between the plasma and liquid. PLAL is a versatile technique for preparing various kinds of Nanoparticles (NPs) such as noble metals, alloys, oxides and semiconductors. The advantages of the PLAL technique are Inexpensive equipment for controlling the ablation atmosphere [2]. Well crystallized NPs can easily be obtained in one –step procedures without subsequent heat treatment, because of the high energetic state of ablated species [3].

Three main steps contribute in laser ablation synthesis method and formation of nanoparticles from a target immersed in liquid. Only in a short period of time, typically about a few microseconds, all these steps take place and nanoparticles are synthesized. Laser pulse, first, heats up the target surface to the boiling point, and thus, plasma plume containing vapor atoms of target is generated. Then, plasma expands adiabatically; and finally, nanoparticles will be generated when condensation occurs. During the condensation step, first, nucleation takes place; then fine nuclei either collide or stick to each other or new materials precipitate on them which result in growth. Nanosized hard agglomerates can form as a result of strong covalent or ionic bonds between nuclei [4].

Nanostructures ZnO materials have received broad attention due to their distinguished performance in electronics, optics and photonics. With reduction in size, novel electrical, mechanical, chemical and optical properties are introduced, which are largely believed to be result of surface and quantum confinement effects [5], Recently, special attention has been devoted to the morphology, as ZnO can form different nanostructures, such as nanobelts, nanoribbons, nanowires, nanotubes, nanohelices, nanorods [6] and Nanoparticles [7].

ZnO nanoparticles do not only have the merits of ZnO semiconductor such as a large exciton binding energy of 60 meV and excellent stability, but also have some novel characteristics because of the particularity of nanostructure, it is well known that small particles have the large surface-to-volume ratio and surface defect [8], Zinc oxide is also a semiconductor and fluoresces in both the UV and visible regions. The peak in fluorescence shifts as a function of particle broken size [9]

Transition metal oxides with nanostructure have attracted considerable interest in many areas of chemistry, physics and material science, thus Zinc oxide Nanoparticles are used in a variety of applications such as UV absorption, photo catalyst, biochemical engineering. It is also used in the fabrication of solar cells, gas sensors, luminescent materials, transparent conductors, heat mirrors and coatings [10].

EXPERIMENTAL WORK

ZnO Nan particles in solution were synthesized by combination of pulsed laser ablation of high purity zinc metal in an aqueous media in DIW at room temperature. A (1×1cm²) high purity (99.99%) Zn plate from (Fluke) was used as a target and fixed at the bottom of open a plastic cell containing 10 ml DIW whose conductivity $2 \times 10^{-6} (\Omega \text{ cm})^{-1}$, the cell holder rotates to avoid a deep ablation traces or crusts. The pure metal target was irradiated with the pulsed Q-switched ND-YAG laser system type (HUAFEI), providing pulses of 1064nm wavelength was used for ablation of

target, the effective beam diameter of (0.72mm) for 1.06 μm were used for laser ablation at constant laser fluence (25 J/cm²) for 1064 nm wavelength focused using a convex lens with a focal length of (11 cm) to create a spark or breakdown in the sample. Figure (1) illustrates typical experimental set up for laser ablation of Zn immersed in DIW.

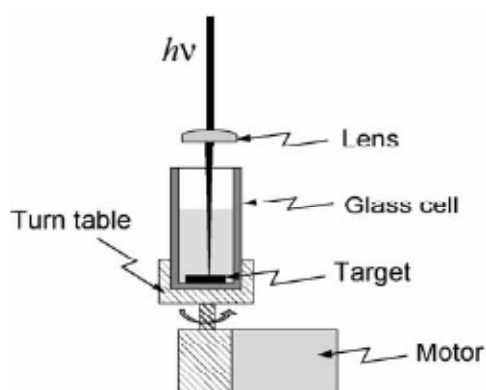

Figure (1) Experimental setup for Nanoparticles synthesis, by laser ablation technique.

The colloidal solution becomes slightly turbid after ablation (smoky like), showing the formation of metal colloidal Nanoparticles, the rapid reactive quenching and aqueous oxidation of highly active Zn clusters in deionized water is responsible for the formation of ZnO Nanoparticles. In this process the initial oxidation product Zn (OH)₂ rapidly decomposes to ZnO cluster (milky like)[11].

The products were characterized by a double-beam UIR-210A spectrophotometer from Shimadzu, and room temperature photoluminescence (PL, LABRM-HR PL spectrophotometer), Fourier Transform-Infrared Spectroscopy (FTIR) from (Shimadzu Iaffinity) and atomic force microscope (AFM AA3000)

RESULTS AND DISCUSSION

The effect of the number of laser pulses on the concentration of ZnO NPs at laser fluence (25 J/cm²) for 1.06 μm laser wavelength is shown in Figure (2).

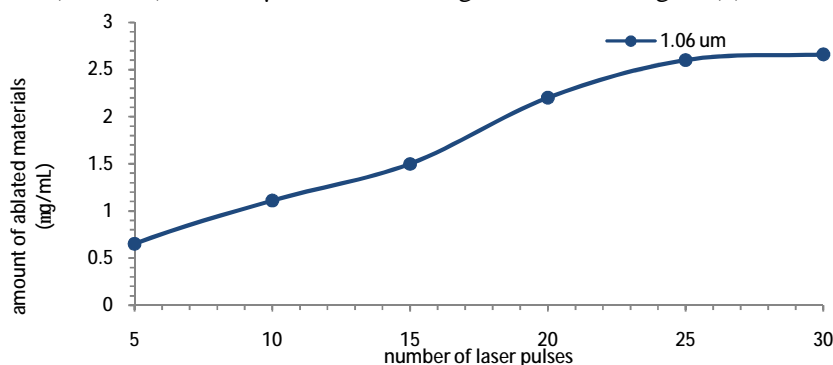
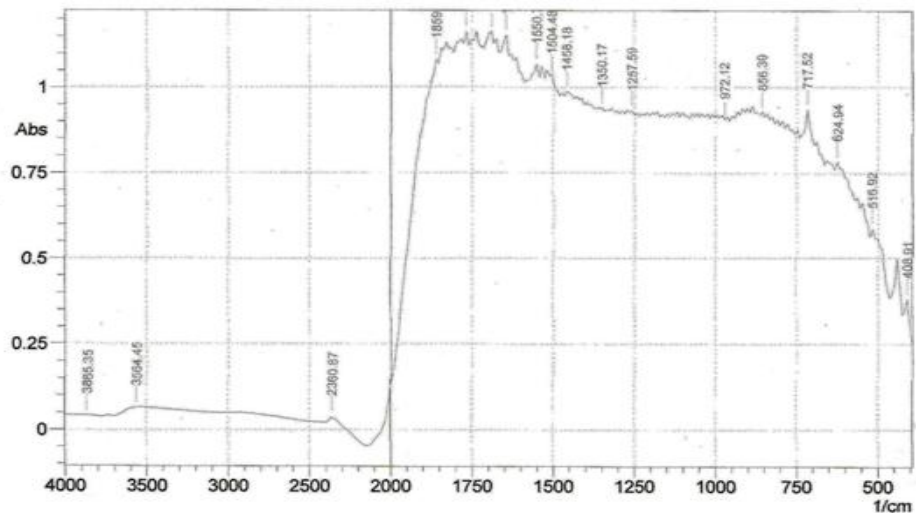

Figure (2) Amount of ablated materials as a function of number of pulses for 1.064 μm laser wavelength at 25 J/cm² laser fluence.

As a result efficiency of laser ablation can be quantified both by the amount of Zn transferred from the Zn target into the liquid ambient, and transferred to ZnO NPs, concentration of ZnO NPs can be varied at given wavelength by factors depend on the value of laser fluence (up to saturation) and by number of pulses.

It has been found that by increasing the number of laser pulses, the amount of the ablated NPs increase, due to the target ablation followed by plasma formation took place mainly during the rising part of laser pulse, in particular for the tight focusing on the target. The situation marks as an onset of nucleation process to form metal oxide Nanoparticles, so that there is a specific number of laser pulses beyond which the amount of the ablated material becomes constant since the increase in the number of laser pulse leads to the formation of dense plasma that itself prevent the laser pulse to reach the target or limited the energy that reaches the target surface.

Figure (3) gives the FTIR result for ZnO NPs prepared at 1.06 μm laser wavelength and different number of pulses (30, 50 pulse) with constant laser fluence of ($25\text{J}/\text{cm}^2$). In this figure we could recognize the absorption peaks at ($439.77, 516.92, 594.08, 408.91, 516.92$) cm^{-1} wave number which are related to the stretching vibrations mode of the Zn-O band [12]. At the same time, we could notice the increase in the intensity of the absorption peak by increasing the number of laser pulses. This is related to the larger amount of the ablated material produced from the target surface, mainly during the arising part of each laser pulse, and then increase in the concentration of ZnO NPs at higher number of laser pulses. Absorption peaks at ($3000, 3564.45, 3865.35, 1481.33$) cm^{-1} are related to the harmonics of H-OH stretching modes, while those at ($1435.04, 1458.18$) cm^{-1} are related to the C-O vibration modes referring to little contribution of CO_2 dissolution from air content [14].



(a)

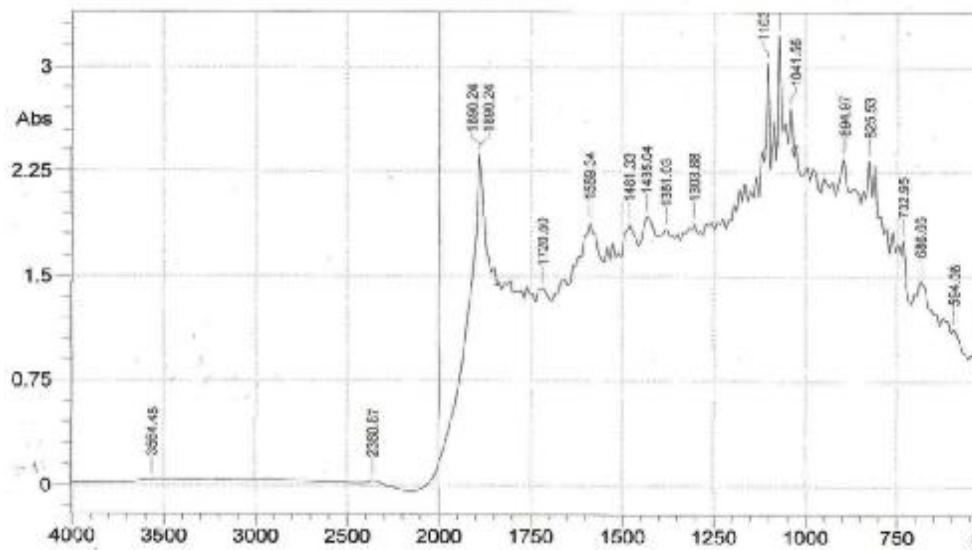

(b)

Figure (3) Fourier transform infrared spectrum of ZnO Nanoparticles in DIW as a thin film on the glass substrate prepared at 1.06 μm laser wavelength with constant laser fluence 25 J/cm² (a) 30 pulses (b) 50 pulses.

The surface morphology of ZnO Nan particles colloidal prepared by LP-PLA at different conditions was obtained using atomic force microscopic images. One drop of the colloidal suspension was dried out on glass substrate at 60 C°. Figure (4) shows the particle size distribution and Nanoparticles topography of dried colloids prepared at different laser pulses (20 and 60) and constant laser fluence. The surface morphology, and hence particles size distribution are recognized.

Larger number of laser pulses lead to a smaller particle size as shown in Figure (4) where (60) laser pulses was used to prepare ZnO NPs at (25 J/cm²) laser fluence average particle size was found to be about (31.75 nm) while average particle size was found to be about (39.11 nm) at 20 pulses because of the longer ablation time leads to a narrowing of the nanoparticle size distribution due to the interaction of the ablating laser beam with the produced Nanoparticles [13],and The decrease in the particle size appear because of laser fragmentation effect. Since laser pulse causes larger particles to participate to smaller and smaller one [15].

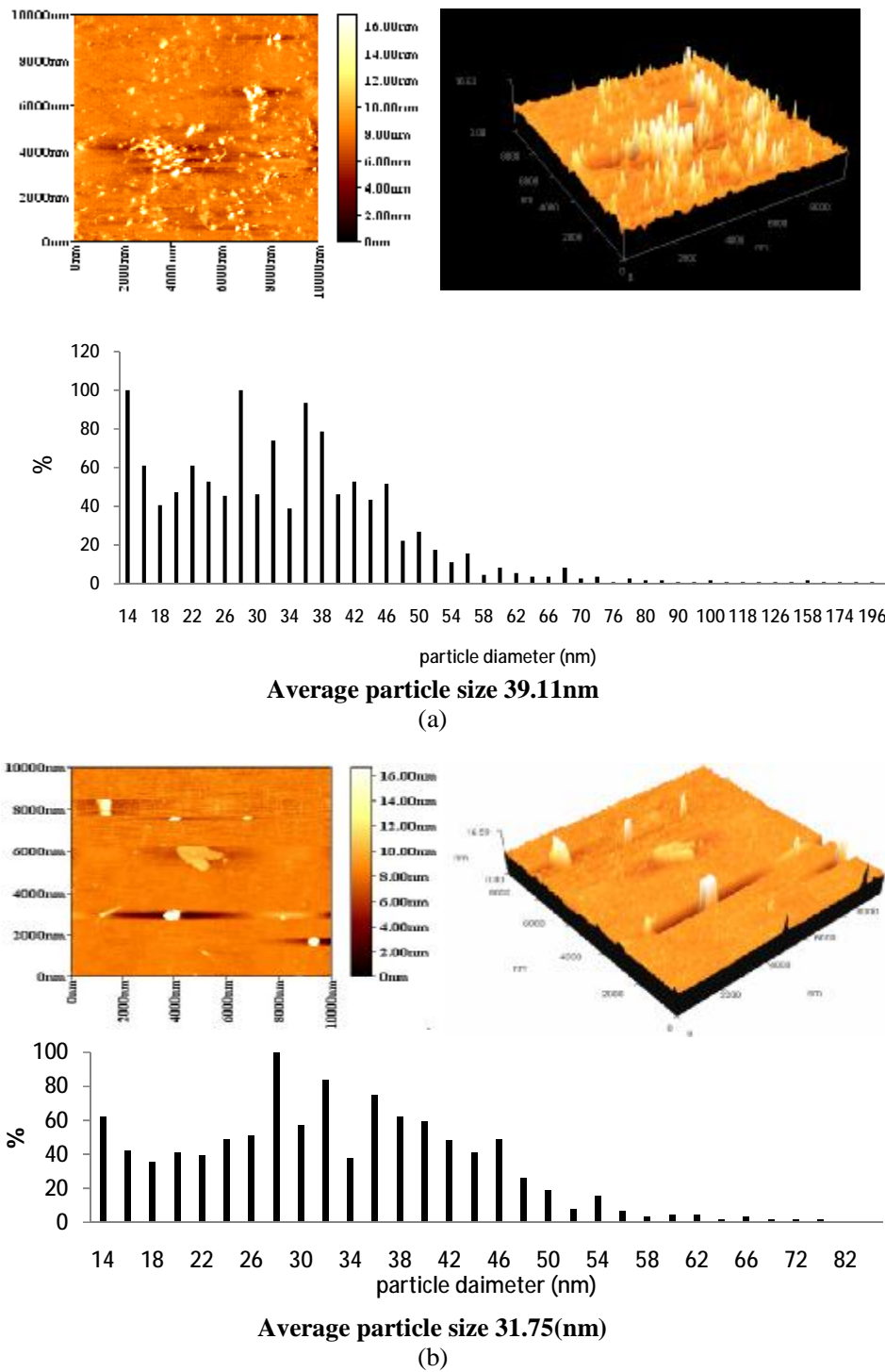

Figure (4) Surface morphology of ZnO NPs prepared at 1.06 mm laser wavelength 25 J/cm^2 (a) at 20 laser pulses (b) at 60 laser pulses.

The UV-VIS transmission and absorbance as a function of wavelength at different laser pulses at 1.06 μm laser wavelength and constant laser fluence (25 J/cm²), Figure (5). Show the overall transmission as a function of ablating laser pulses of Zn metal in colloidal suspension a lower transmittance value due to larger amount of ablated Zn material, while the absorbance of ZnO nanoparticles increased with the number of laser pulses, and a blue shift could be recognized in the absorbance of ZnO colloidal resulted from smaller particle size (larger energy gap).

This result is in consistence with the relationship between the band gap energy and the size of the particles considered as spherical particles can be given by the following equation

$$E_g^* = E_g + \frac{h^2}{8\mu R^2} + \frac{1.8e^2}{4\pi\epsilon_0\epsilon_\infty R}$$

where, E_g is the bulk band gap of the semiconductor material, μ the effective mass of the exciton given by $1/\mu = 1/m_e^* + 1/m_h^*$ (m_e^* is the electron effective mass and m_h^* is the hole effective mass), R the radius of the particle, ϵ_0 is the vacuum permittivity and ϵ_∞ is the relative permittivity [14], this equation is an approximate equation and valid for value of grain size less than or equal an exciton bohr radius. And from AFM microscope in Figure (4) the particle size of ZnO nps were larger than the dimension of an exciton bohr radius (1.4-2.3nm).

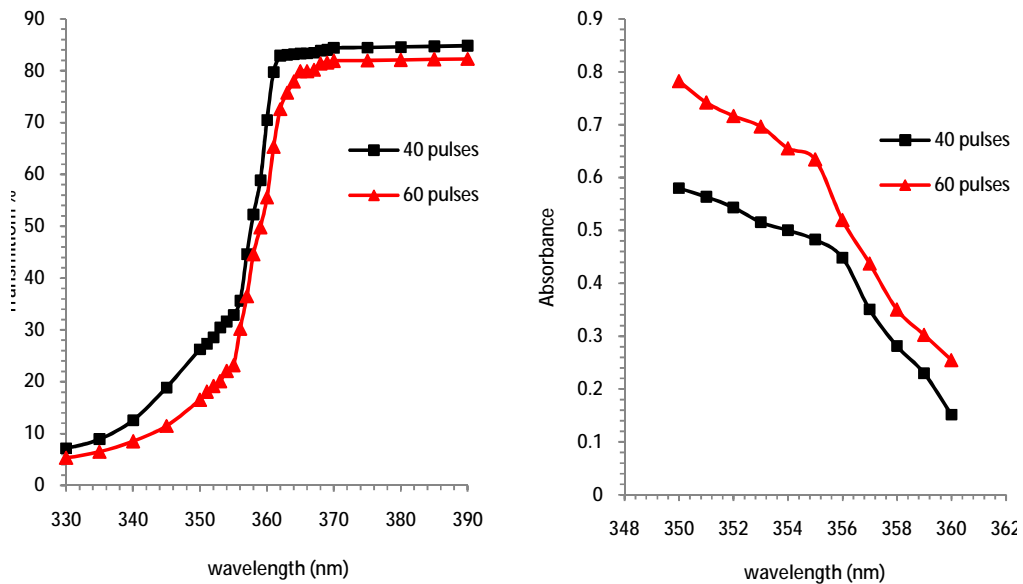

(a)

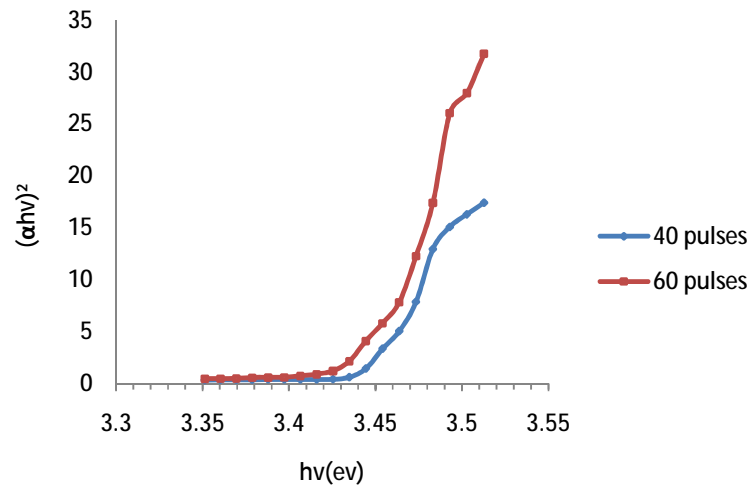

(b)

Figure 5(a)Optical transmission and absorption as a function of wavelength for ZnO NPs prepared by LP-PLA at different number of pulses at 1.06 μm laser wavelength with constant laser fluence of 25 J/cm² , (b) (αhv)² as a function of incident photon energy at 40 and 60 pulses.

The optical band gap of the nanoparticles was estimated from an extrapolation of a plot of (αhv) as a function of the photon energy in the absorption spectra. This is possible because the absorption coefficient (α) can be expressed as $\alpha h\nu \propto (h\nu - E_g)^{1/2}$ and the intercept provides a good approximation to the band gap (E_g) [16]. From Figure (5 b) It has been found that energy band gap 3.425ev and 3.44 ev for 60 and 40 pulses respectively.

Figure (6) shows the effect of the number of laser pulses on Photoluminescence properties and intensity of the ZnO Nanoparticles colloidal.

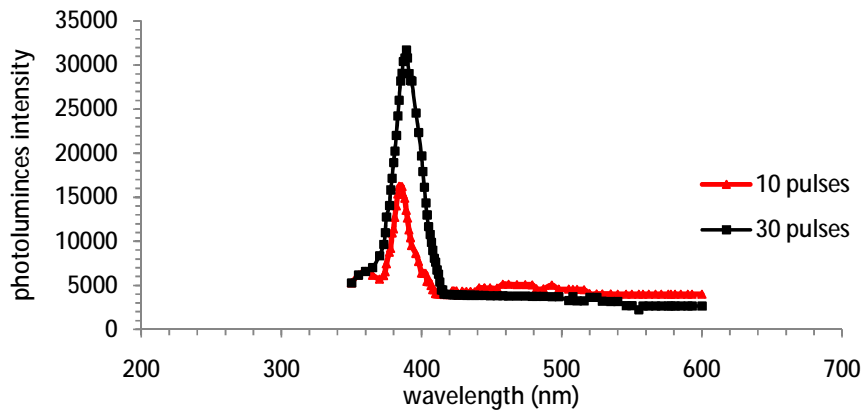

Figure (6) PL spectra of ZnO nanoparticle solutions prepared with laser fluence 25 J/cm² at different number of pulses at 1.06 μm laser wavelength.

This Figure indicates that photoluminescence intensity of the UV near band edge emission peaks located at 381, 384nm increases with the increase of number of pulses, while the broad small band at green region, presumably is associated with the intrinsic defects in ZnO and with oxygen vacancies on the surface of Nanoparticles.

CONCLUSIONS

This method provides an alternative, pollution free, way for the synthesis of oxides nanoparticles of metals. In summary, we have demonstrated that laser pulses is an effective parameter to adjust the amount of ablated materials, structure, morphology and optical properties of ZnO Nanoparticles prepared by laser ablation in DIW. Efficiency of laser ablation increased with larger number of laser pulses, The Fourier transform infrared spectroscopy result shows that the intensity of the Zn-O bond vibrational mode is proportional directly to the number of laser pulses, and the AFM results show decrease in particle size with increase in number of laser pulses. The UV-Vis result show a lower transmittance value due to larger amount of ablated Zn material but in other hand a blue shift could be recognized in the absorbance of ZnO colloidal resulted from smaller particle size (larger energy gap) that appear because of laser fragmentation effect. Finally the photoluminescence intensity of the UV near band edge emission peaks increases with the increase of number of pulses, we could notice the increase in the intensity of the absorption peak by increasing the number of laser pulses.

REFERENCES

- [1]. Gondal, M.A. Q.A. Drmash, Z.H. Yamani, T.A. Saleh "Synthesis of ZnO₂ nanoparticles by laser ablation in liquid and their annealing transformation into ZnO nanoparticles" *Applied Surface Science*, vol. 256, P: 298- 304, 2009.
- [2]. Takeshi Sasaki, C.He, Yoshiki "Synthesis of ZnO nanoparticles using nanosecond pulsed laser ablation in aqueous media and their self-assembly towards spindle-like ZnO aggregates" *Applied Surface Science*, vol. 254, P:2196–2202, 2008.
- [3]. Zeng,H. Z. Li, Weiping Cai, B. Cao, P. Liu, and S.Yang "Microstructure Control of Zn/ZnO Core/Shell Nanoparticles and Their Temperature-Dependent Blue Emissions" *J. Phys. Chem. B*, vol.111, P:14311-14317, 2007.
- [4]. Arash Baladi, Rasoul Sarraf Mamoori "Investigation of different liquid media and ablation times on pulsed laser ablation synthesis of aluminum nanoparticles" *Applied Surface Science* 256 (2010) 7559–7564.
- [5]. Keshavarzi, A. "Effects of synthesis methods on the physicochemical properties of micro –and nano –sized zinc oxide", University Putra Malaysia UPM, requirement of the degree of master, 2009.
- [6]. Ishikawa,Y. Y. Shimizu, T. Sasaki, N. Koshizaki "Preparation of zinc oxide nanorods using pulsed laser ablation in water media at high temperature" *Journal of Colloid and Interface Science*, vol.300, P: 612–615, 2006.
- [7]. Gao1,T. G. Meng, Y. Tian, S. Sun, X. Liu and L. Zhang "Photoluminescence of ZnO nanoparticles loaded into porous anodic alumina hosts" *J. Phys.: Condens. Matter*, vol 14, p:12651–12656, 2002.

- [8]. Tong, Y.H. Y.C. Liu, S.X. Lu And L. Dong,S.J. Chen,And Z.Y. Xiao "The Optical Properties of ZnO Nanoparticles Capped with Polyvinyl Butyral" *Journal of Sol-Gel Science and Technology*, vol. 30, p:157–161, 2004.
- [9]. W. Penny S. Hale, L. M. Maddox, J. G. Shapter, and N. H. Voelcker "Growth Kinetics and Modeling of ZnO Nanoparticles" *Journal of Chemical Education*, vol. 82, no. 5 , 2005.
- [10]. Faal Hamedani and F. Farzaneh, N. "Synthesis of ZnO Nanocrystals with Hexagonal (Wurtzite) Structure in Water Using Microwave Irradiation" *Journal of Sciences, Islamic Republic of Iran* , vol.17, no. 3,P:231-234 , 2006.
- [11]. Singh, S.C. R. Gopal" Synthesis of colloidal zinc oxide nanoparticles by pulsed laser ablation in aqueous media" *Physical E* ,vol .40, P: 724–730, 2008.
- [12]. Deng, L. Li, J. H. Deng, Z. Liu, L. Xin "Synthesis and characterization of chitosan/ZnO nanoparticle composite Membranes" *Carbohydrate Research* , vol 345, P: 994–998, 2010.
- [13]. Semaltianos,N. G. S. Logothetidis .W. Perrie . S. Romani. R. J. Potter. S. P. Edwardson . P. French. M. Sharp. G. Dearden. K. G. Watkins "Silicon nanoparticles generated by femtosecond laser ablation in a liquid environment" *J Nanopart Res.springer science +business media B.V*, 2009.
- [14]. Said, A. L. Sajti, S. Giorgio and W. Marine "Synthesis of nanohybrid materials by femtosecond laser ablation in liquid medium" *IOP Publishing Journal of Physics: Conference Series*, no.59, P: 259–265, 2007.
- [15]. Tarasenko, N.V. V.S. Burakov, and A.V. Butsen "Laser Ablation Plasmas in Liquids for Fabrication of Nanosize Particles" *publ.astron .obs.belgrade No. 82*, P: 201-211, 2007.
- [16]. Kuk ki , Daehyun kim ,Sang kyu kim " formation of zno nanoparticles by laser ablation in neat water " *chemical physics letters*,vol.511,p:116-1210),2011.